



Bulk Material Handling and Mining Electrification Systems





Conductix-Wampfler – The Global Leader in Energy and Data Transmission Systems

Who we are

Conductix-Wampfler is an international company focused on energy and data transmission systems for bulk material handling and mining equipment. We also serve the container handling, primary metals processing, energy and offshore, general material handling, logistics and automation industries.

Our Mission

We strive to keep your bulk handling and mining operations up and running 24/7/365. We have been active in the industry for over 80 years and understand the needs of your business. We work closely with you to build long-term partnerships.

Our Products

Our reeling systems, festoon systems, and energy guiding chains safely handle cables and hoses under demanding conditions. We are also specialists in conductor rail systems, slip ring assemblies and crane controls. Our products have been rigorously tested and manufactured to high standards.

Systems are engineered to meet your specifications and withstand the harsh operating conditions in mines, bulk storage facilities and bulk terminals.

ISO9001:2008 Registered

Global Experience – Local Service

Conductix-Wampfler's worldwide sales network supports our global and local customers with reliable products and customized solutions. We serve more than 80 countries worldwide. Our expert specialists, located in strategic "Centers of Excellence", manage turnkey projects as well as design, engineer, and manufacture products. Our production is supported by local manufacturing sites around the world.



Stackers, Reclaimers

Page 6

Portal Stackers, Radial Arm Stackers

Page 8

Tripper Conveyors,
Travelling Hoppers and Grabs

Page 10

Ship/Barge Loaders/Unloaders,
Rail Car Dumpers

Page 12

Mobile Mining Machines

Page 14

Electrowinning Process Cranes

Page 16

Maintenance Areas

Page 18





Conductix-Wampfler Products – Built to last under demanding conditions

Motor Driven Reels

For Cable and Hose Management

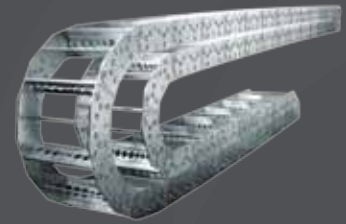

Corrosion Resistant Conductor Bar Systems

For Process and Maintenance Cranes

Energy Guiding Chains

For Cable and Hose Management

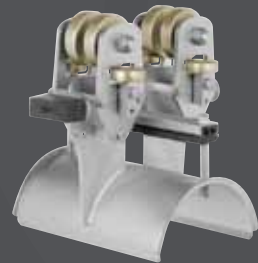

Festoon Systems

For Cable and Hose Management



Stackers, Reclaimers

Conductix-Wampfler

keeps the world's busiest stock yards moving, whether at mine sites, bulk ports, primary metal mills or power plants. We supply electrification for all types of stackers and reclaimers:

- Bridge Reclaimers
- Bucket Wheel Reclaimers
- Radial Stackers
- Rotary Boom Stackers
- Stack Rakes
- Special Bulk Handling Machines

Energy Guiding Chains

For moving machines, we can assemble energy guiding chains in lateral or circular configurations to reliably manage hoses and cables.

Motor Driven Reels

For long travel, we supply rugged magnetic coupler reels or the latest in VFD controlled reeling systems. These feature modular components that stand up to demanding and dusty environments. We also supply reels designed for hazardous locations.

Spool Configurations:

- Monospiral
- Level Wind
- Bulk-wrap / Random Wind

Cable Festoon Systems

Rugged and reliable cable festoon systems are available in a wide array of configurations. These systems are ideal for straight runs or in circular configurations for rotating machines.

To save you time and money at the job site, we can pre-assemble your festoon in our factory before shipment.



Level Wind Reels on a Stacker/Reclaimer, Australia



Motor Driven Cable Reel on a Stack Rake, USA



Level Wind Reel on a Stacker/Reclaimer, USA



Motor Driven Cable Reel on a Stacker, Czech Republic



Festoon System
on a Stacker/Reclaimer, Australia



Motor Driven Cable Reel
on a Stacker, Australia



Motor Driven Cable Reel
on a Stacker/Reclaimer, Thailand

Portal Stackers, Radial Arm Stackers

Conductix-Wampfler

keeps the busiest stock yards operating at bulk ports and storage facilities around the globe. We supply electrification for specialized stackers and reclaimers such as:

- Portal Stackers
- Radial Arm Stackers
- Rotating Stackers
- Gantry-type Stackers
- Bridge Reclaimers

and many other types.

Motor Driven Reels

For long travel, we can supply rugged magnetic coupler reels or the latest VFD controlled reeling systems. These feature modular components that stand up to demanding and dusty environments. We also supply reels designed for hazardous locations.

Spool Configurations:

- Monospiral
- Level Wind

Cable Festoon Systems

Rugged and reliable cable festoon systems are available in a wide array of configurations. These systems are ideal for straight runs or in circular configurations for rotating machines.

To save you time and money at the job site, we can pre-assemble your festoon in our factory before shipment.

Energy Guiding Chains

For moving machines, we can assemble energy guiding chains in lateral or circular configurations to reliably manage hoses and cables.



Motor Driven Cable Reel on a Portal Reclaimer, Australia



Motor Driven Reel on a Portal Stacker, Russia



Festoon System on a Bridge Reclaimer, Australia



Motor Driven Cable Reel on a Portal Stacker, USA

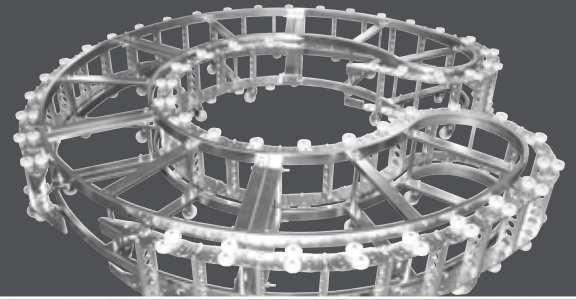
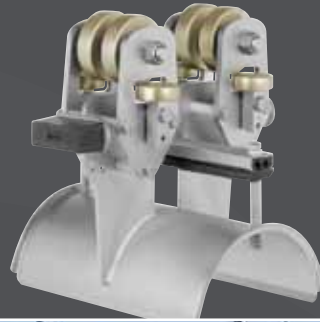

Photo: Bernard S. Jansen



Motor Driven Cable Reels on a Radial Stacker, United Kingdom



Festoon System on a Portal Stacker, Australia



Festoon System on a Circular Bridge Reclaimer, USA

Tripper Conveyors, Traveling Hoppers, and Grabs

Conductix-Wampfler

keeps your material flowing with electrification systems designed to power all types of tripper conveyors and traveling hoppers.

Motor Driven Reels

For linear runs, we supply rugged magnetic coupler reels that feature modular components that stand up to demanding applications.

Spool Configurations:

- Monospiral
- Level Wind
- Bulk-wrap / Random Wind

Cable Festoon Systems

For shorter runs and multiple cables, reliable cable festoon systems are an appropriate option. These systems are ideal for straight runs and those arranged in circular configurations for rotating machines.

In addition to I-beam running systems, we offer festoons that run on "diamond track" (square rail) to reduce dust accumulation.

To save you time and money at the job site, we can pre-assemble your festoon in our factory before shipment.



Motor Driven Cable Reels on a Tripper Conveyor, Venezuela



Motor Driven Cable and Hose Reels on a Tripper Conveyor, Venezuela



Festoon System on a Tripper Conveyor, Venezuela

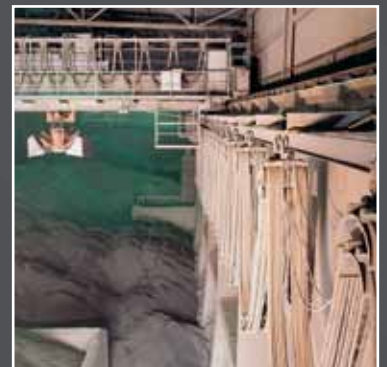

Festoon System on a Bridge Crane with Grab, Germany



Motor Driven Cable Reel
on a Tripper, Chile



Festoon System
on a Conveyor, Chile



Festoon System
on a Traveling Hopper, Peru

Ship/Barge Loaders/Unloaders, Rail Car Dumpers

Conductix-Wampfler

keeps the world's busiest bulk ports moving with electrification systems that can handle seaside bulk handling machinery.

We provide power for:

- Ship Loaders
- Ship Unloaders
- Barge Loaders
- Barge Unloaders
- Stock Yard Stackers/Reclaimers

In addition, we supply festoon systems used for indexers on rail car dumper systems.

Motor Driven Reels

For long travel, we supply rugged magnetic coupler reels featuring modular components to withstand the demanding ocean and river environments. We also build reels with the latest VFD control systems. Reels are usually configured with Monospiral Spools.

Cable Festoon Systems

Rugged and reliable cable festoon systems are available in a wide array of configurations. These systems are ideal for straight runs as well as in a circular configuration for rotating machines. Festoon systems are ideal for the rail car indexing systems used with car dumper systems.

To save you time and money at the job site, we can pre-assemble your festoon in our factory before shipment.



Motor Driven Cable Reels on a Ship Unloader, Germany



Festoon System on a Rail Car Dumper System, China



Motor Driven Cable Reel on a Ship Unloader, France



Conductor Bar System on a Rail Car Dumper, Australia

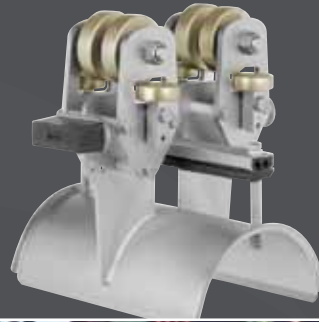

Festoon System
on a Rail Car Dumper, Australia



Motor Driven Cable Reel
on a Ship Unloader, Korea



Motor Driven Cable Reels
on a Ship Loader, USA

Mobile Mining Machines

Conductix-Wampfler

keeps critical open pit and underground mines running with extremely reliable electrical components that deliver power where and when you need it. Our equipment can handle the G-forces, vibrations, and tough environments that today's mining equipment is subjected to.

We have become the supplier of choice for mobile electrification components such as:

Trailing Cable Reels for

- Electric Rope Shovels
- Rock Drills and Blasthole Drills
- Draglines

Cable Reels and Energy Guiding Chains for

- Shotcrete Machines
- Roof Bolters
- Tunnel Boring Machines (TBMs)

Slip Ring Assemblies for

- Electric Rope Shovels
- Rotary Boom Reclaimers
- Cable Reels

We build all the slip rings used in Conductix-Wampfler Cable Reels and can replace them in other reels.



Slip Ring Assembly on an Electric Rope Shovel, Canada



Trailing Cable Reel on a Blasthole Drill, USA



Slip Ring Assembly on an Electric Rope Shovel, Chile



Trailing Cable Reel on a Blasthole Drill, Chile

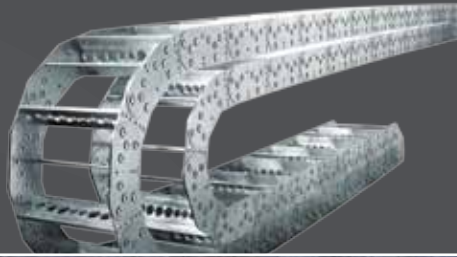

Motorized Cable Reel
on a Tunnel Boring Machine, India



Motor Driven Hose Reel
on a Shotcrete Machine, Spain



Motorized Cable Reel
on a Bucket Wheel Excavator, Germany

Electrowinning Process Cranes

Conductix-Wampfler

provides specially configured electrification systems for process cranes operating in extremely corrosive electrowinning environments. You can rely on our conductor bar and festoon systems to run reliably under the most demanding conditions.



Hevi-Bar II Conductor Bar With Dura-Coat Protection

Our unique "Dura-Coat" corrosion protection for Hevi-Bar II greatly increases the life of aluminum components. This ceramic-based coating is extremely resistant to the types of corrosives found in electrowinning facilities.

Hevi-Bar II features:

- V-Contact bar for superior conductivity
- Robust design for long life
- Current capacities from 500 to 1500 amps and more
- Insulator covers for standard, medium, and high heat applications.

Cable Festoon Systems

Rugged and reliable cable festoon systems are available in an array of configurations. These systems are ideal for all types of overhead bridge crane power and control cabling.

Festoon hardware is available in either galvanized or stainless steel depending on the application.

To save you time and money at the job site, we can pre-assemble your festoon in our factory before shipment.



Conductor Bar and Festoon System on an Electrowinning Process Crane, Chile



Festoon System on an Electrowinning Process Crane, Peru



Festoon System on an Electrowinning Process Crane, Chile



"Dura Coat" Conductor Bar System on an Electrowinning Process Crane, Chile

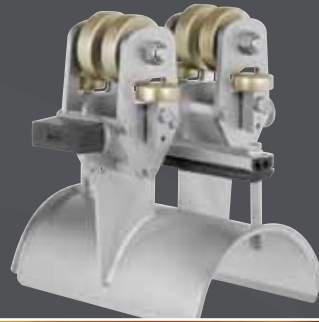

"Dura Coat" Conductor Bar System on an Electrowinning Process Crane, Chile



"Dura Coat" Conductor Bar System on an Electrowinning Process Crane, Chile



Finished Copper Sheets Coming Off the Line

Maintenance Areas

Conductix-Wampfler

understands the importance of your maintenance facilities. Hard working mining and handling machinery must be kept in excellent condition. To help you do that, we offer an array of crane electrification systems, power delivery equipment, and crane control products.

Conductor Rails

We manufacture more conductor rails than anyone in the world. Capacities range from 100 amps to 1500 amps and more – to power any crane runway.

Cable Festoon Systems

Rugged and reliable cable festoon systems are available in an array of configurations. These systems are ideal for bridge power and control cables for all types of overhead cranes.

Cable Reels

If you need a spring-driven cable reel for drop lights, portable power outlets, or to power a moving machine, Conductix-Wampfler has what you need.

Push Button Pendants and Radio Remote Controls

Conductix-Wampfler offers reliable, ergonomic push button pendants and radio controls for all your crane operating needs.



Conductor Bar and Festoon System on an EOT Crane, Colombia



Conductor Bars on an EOT Crane, USA



Festoon System on an EOT Crane, USA



Festoon System on an EOT Crane, Czech Republic

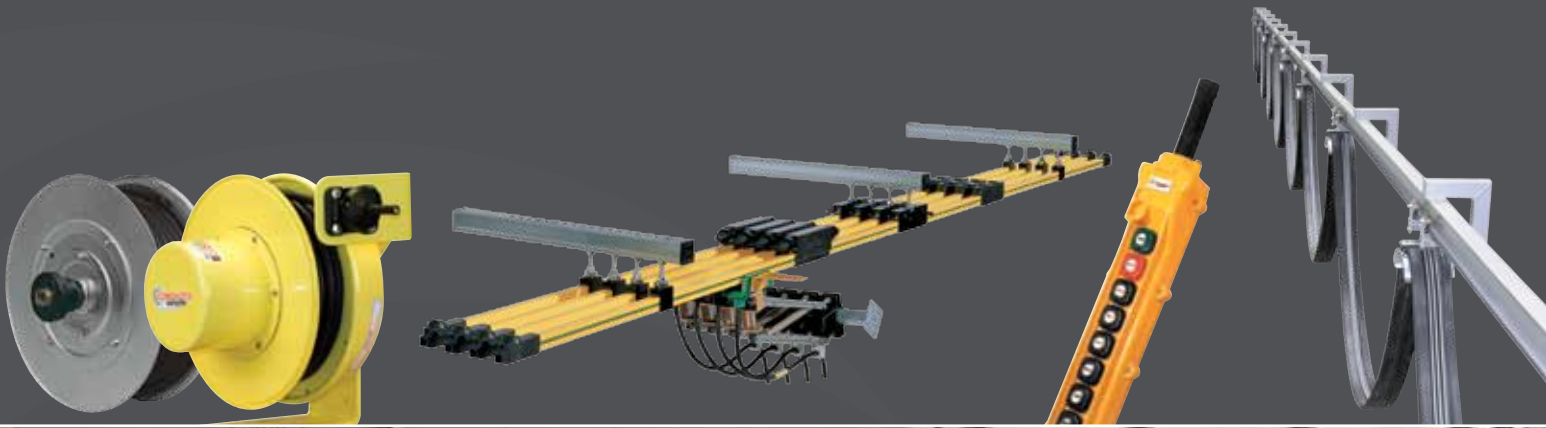

Conductor Bar
on a Maintenance Crane, Chile



Push Button Pendant
on an EOT Crane, Australia



Radio Remote Control
on an EOT Crane, El Salvador

Mining and Bulk Handling Companies

We are Proud to Serve:

Equipment Manufacturers and Engineering Firms:

- Atlas Copco
- Bechtel
- Cargotec
- Caterpillar/ Bucyrus International
- FAM
- FLSmidth
- Fluor
- Hatch
- Joy Global/P&H Mining
- Kinder Morgan
- Konecranes
- Metso Minerals
- Richmond Engineering Works
- River Consulting
- Sandvik
- Sinclair Knight Mertz
- Tenova TAKRAF
- ThyssenKrupp
- WorleyParsons
- ZPMC

Operators:

- Alcoa
- Arch Minerals
- BHP Billiton

- Drummond Coal
- Fortescue Metals Group
- Kennecott Copper
- Phelps Dodge
- Rheinbraun
- Rio Tinto
- Ruhrkohle AG
- Southern Peru Copper
- Sunco
- US Borax
- Xstrata

A few of the Mine Sites We Serve:

- Antamina
- Cerro Colorado
- Collahuasi
- Cuajone
- El Abra
- El Tesoro
- Escondida
- Las Bambas
- Los Pelambres
- Michilla
- Quebrada Blanca
- Spence
- Tintaya
- Toquepala
- Zaldivar







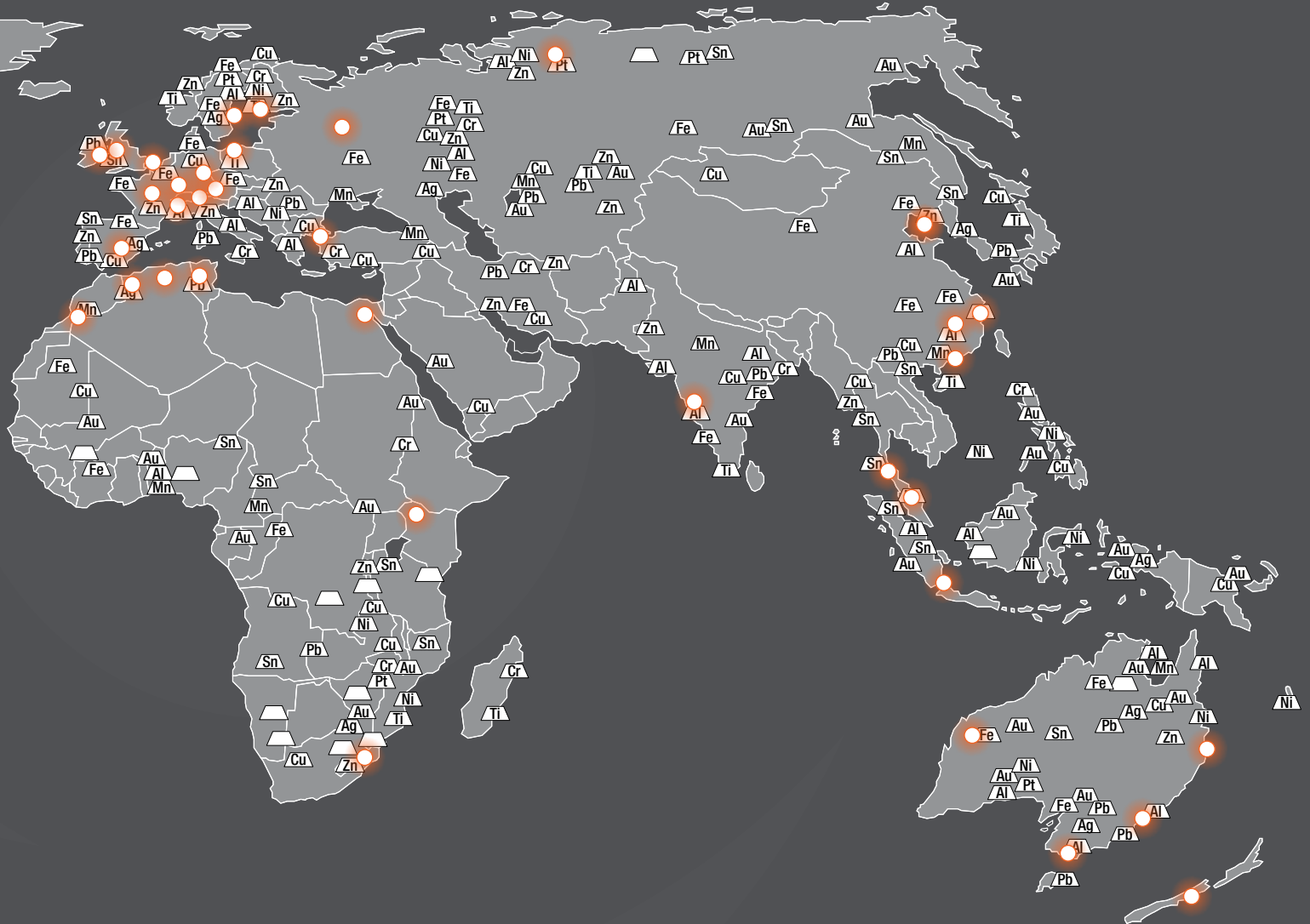









... just a call away

Serving the Mining and Bulk Handling Industry from Locations all Around the Globe



 **Conductix-Wampfler Offices and Representatives**
 For contact information, please visit:
www.conductix.com

- | | | | |
|--|--|--|--|
|  Bauxite |  Gold |  Nickel |  Titanium |
|  Chromium |  Iron |  Platinum |  Zinc |
|  Copper |  Lead |  Silver | |
|  Diamonds |  Manganese |  Tin | |



Custom Services you can count on!

You can count on Conductix-Wampfler to meet your specific service needs and requirements. With our expert teams everything is possible, from initial design and development to long term service contracts.

The more complex your system, the greater your service life and operational reliability expectations are and the more sense it makes to take advantage of our after-sales service.

When it comes to service, you can count on Conductix-Wampfler to perform!

The Turnkey Solution

As a system supplier, Conductix-Wampfler offers you complete turnkey solutions. This includes the delivery of all necessary parts to complete your project.

We consider qualified consulting, project engineering of the complete system, the choice and selection of the right components, optimizing the accessories, the adequate logistic concept, and the commissioning on site to be important elements of Conductix-Wampfler's business activities.

Planning and Development

- Definition of the application parameters
- Selection of the proper components for the required system, optimized to your requirements, application parameters, and environmental factors
- Selection of the optimum energy supply solution in cooperation with you, our customer, as a function of all considerations including cost, service life, operating parameters, installation, and site requirements

Final Assembly

- Supervision of construction, assembly, and mounting on site, or
- Complete installation by our trained specialists

Service Agreement

- Regular maintenance and inspections to increase the operational life of your facility, ensuring long-term performance and availability
- All services required on site in the event of an incident, including spare parts and replacement materials
- Conductix-Wampfler service agreements: The "Worry-Free Package"



Ten Good Reasons for Using Conductix-Wampfler Energy & Data Transmission Systems:

At Conductix-Wampfler, we will:

- Supply the latest technical solutions for bulk handling and mining electrification
- Optimize your system regardless of which configuration you use
- Provide state-of-the-art drive systems for reels
- Deliver the best value in our industry with the right systems technology and service
- Provide the best system durability and lowest product life cycle costs
- Meet your most demanding requirements and conditions
- Comply with stringent product quality measures (we are ISO 9001:2008 certified)
- Deliver on short notice and provide fast assembly times
- Offer worldwide, comprehensive pre-sale and after-sale service

And last, but not least:

- Apply our more than 80 years of successful mining industry expertise and experience to your project!



www.conductix.com

Conductix-Wampfler has just one critical mission:

To provide you with energy and data transmission systems
that will keep your operations up and running 24/7/365.

www.conductix.com

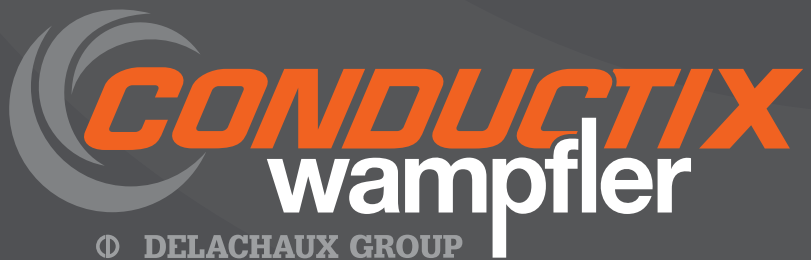
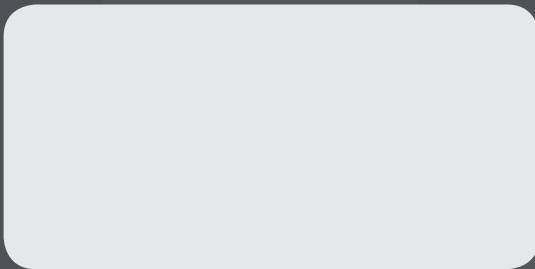

Ⓞ DELACHAUX GROUP