

Engineering Guidelines

Festoon Systems for I-Beams

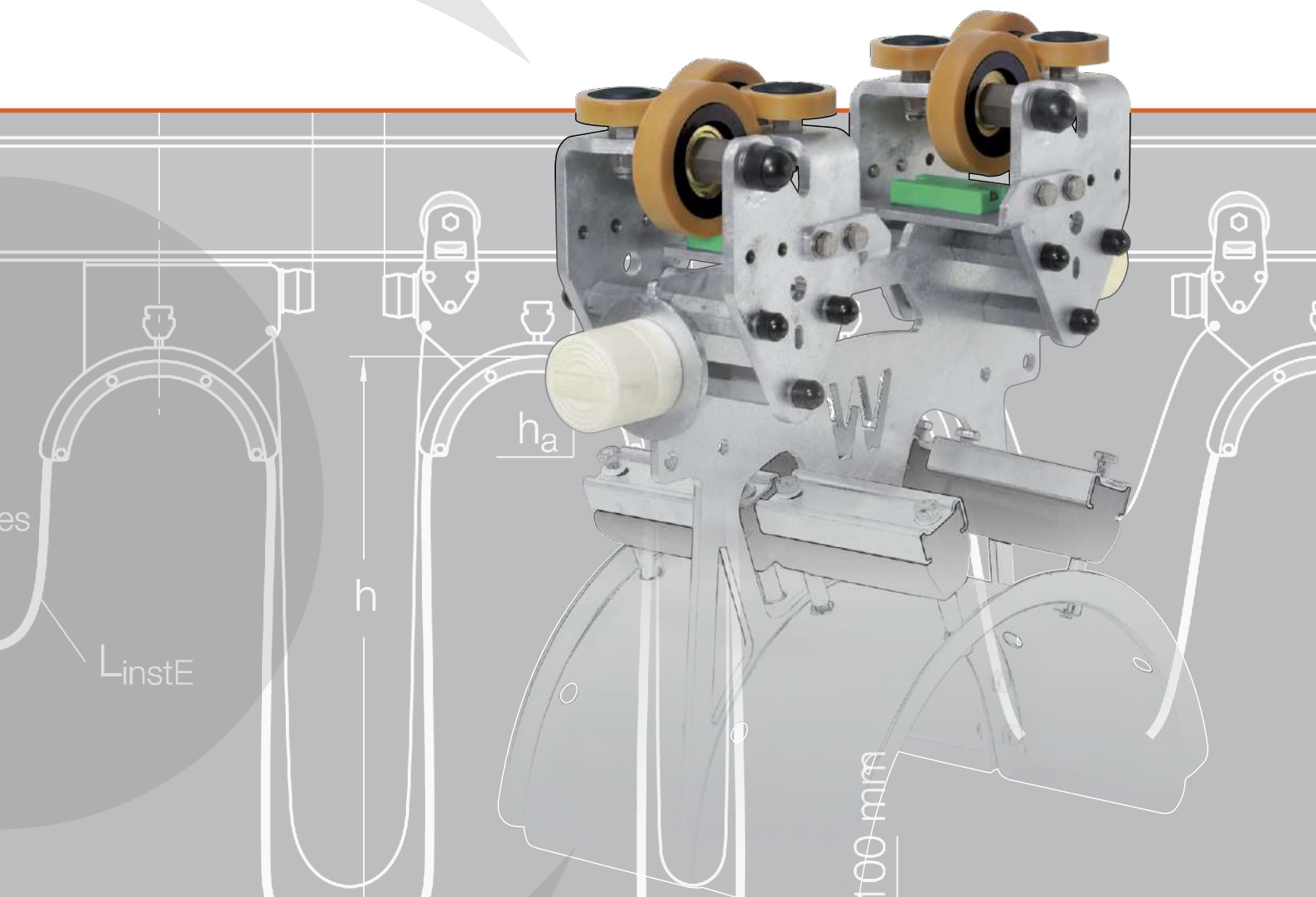

CONDUCTIX
wampfler

Ⓞ DELACHAUX GROUP



Conductix-Wampfler – Proven Expertise with Heavy Duty Cable and Hose Trolleys

Whenever materials need to be moved, Conductix-Wampfler can provide customized solutions for flexible energy, data, air, and fluid transmission.

Conductix-Wampfler is well known for its many years of experience and wide know-how in the development and manufacturing of festoon systems.

Heavy Duty trolleys carry flat and round cables for the transmission of electrical energy and data as well as hoses for the transmission of liquids, air or gases.

Conductix-Wampfler festoon systems are used in various applications all over the world, such as steel works, ports, galvanizing lines, bulk material handling, and composting plants.

This engineering guide will assist you with the layout of non-motorized festoon systems and provides the basic data for the calculation of the system.



Info

This symbol indicates further Information about relevant facts.

Structure and Content

Components	4
System illustration	5
Layout	
• Step 1 Selection and arrangement of cables	6
• Step 2 Selection of the cable trolley program	8
• Step 3 Calculation of the system	14
Sizes and units	16

Typical Components of an I-Beam Cable Trolley

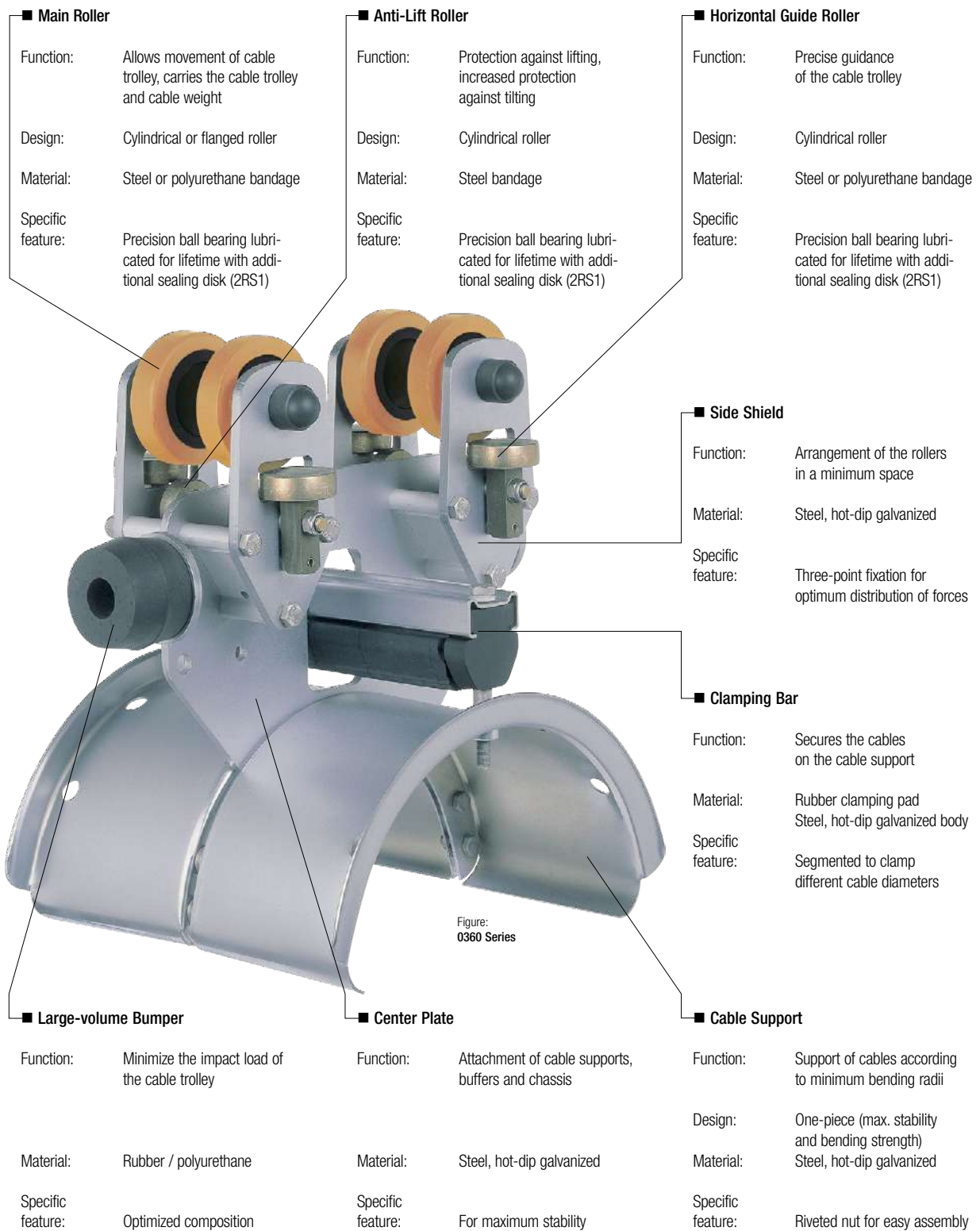

System Illustration

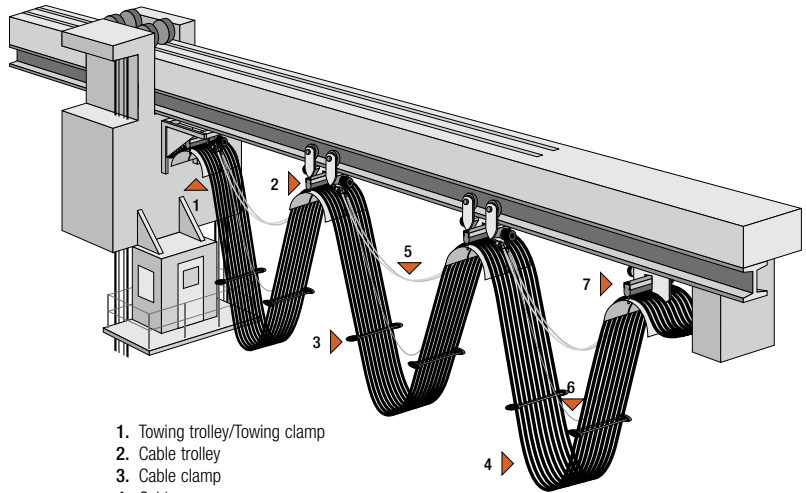

1. Towing trolley/Towing clamp
2. Cable trolley
3. Cable clamp
4. Cables
5. Damping device
6. Towing rope
7. End clamp

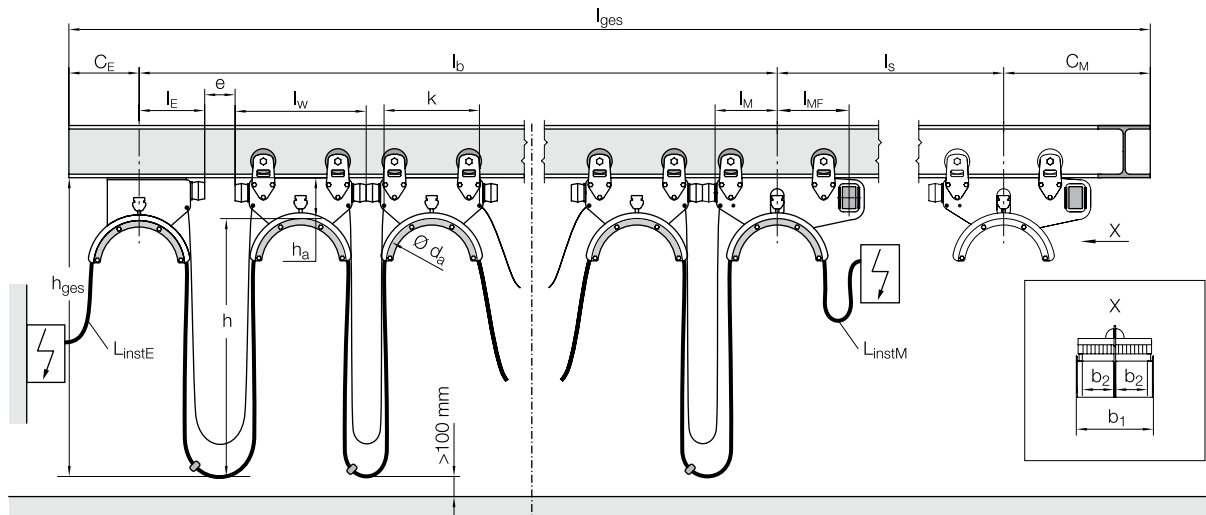

System with Towing trolley

b_1	Cable trolley width
b_2	Max. permissible clamping width
C_E	Beam clearance end clamp side
C_M	Beam clearance towing side
d_a	Cable support diameter
e	Free space within storage distance
h	Cable loop depth
h_a	Cable trolley height from lower edge of beam to upper edge of cable support
h_{ges}	Cable loop depth from lower edge of beam to loop bottom
k	Drill hole distance for towing rope connection
l_b	Storage distance including free space (e)
l_E	End clamp length
l_{ges}	Track beam length
l_{instE}	Installation length end clamp side
l_{instM}	Installation length towing side
l_K	Towing clamp length
l_M	Towing trolley length
l_{MF}	Distance from middle of towing trolley to middle of towing trolley twindow
l_s	Active travel (e.g. main trolley or crane travel)
l_w	Cable trolley length

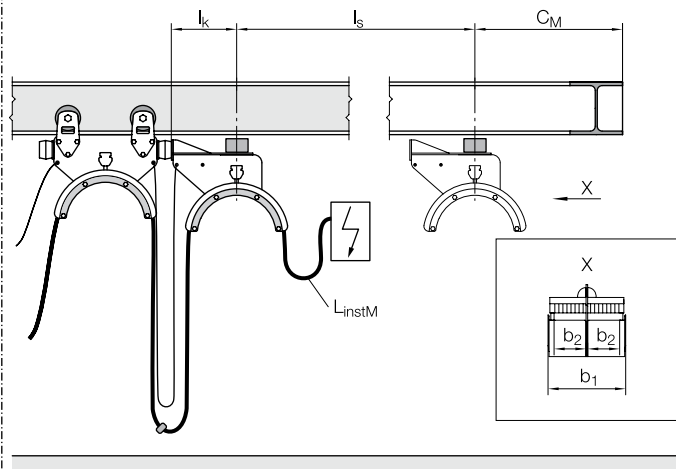

System with Towing clamp

Layout Step 1

Cable Selection and Arrangement

The first steps to lay out a festoon system are:

- Prepare a list of required cables and their cross sections.
- Select the appropriate type of cable (flat or round cable) and the appropriate composition for the respective application (PVC or Neoprene cable) from our cable offering.

Prior to selecting the required cable trolleys it is important to follow the recommendations listed on the right for the layout of the cable package:

Arrangement of flat cables on the cable support

The flat cable package must be arranged so that all cables are tightly clamped on the cable support and cannot slip.

The cable package should not be too tall in relation to the width. Otherwise the cable package will be unstable and individual, especially smaller cables, will not stay sufficiently clamped.

The larger size power cables (e.g. 4 x 50) should be placed on top of the cable package. This will assure good heat dissipation and proper clamping of the smaller cables.

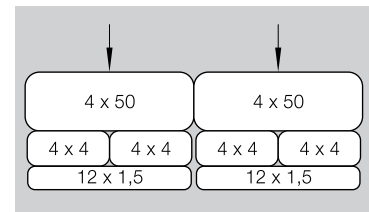

Dynamic forces that occur as the festoon system moves can be partly absorbed by the larger cables.

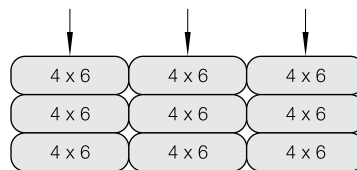

Very good – 100% clamping

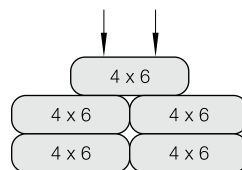

Good – 50% clamping

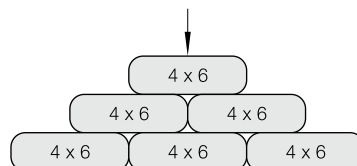

Bad

Whenever possible wider cables should be used instead of multiple smaller cables, e.g.:
1 piece of 12 x 1.5 instead of 3 pieces of 4 x 1.5



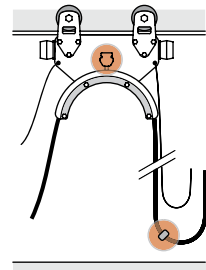

Arrangement of flat cables within the cable clamp

Cable clamps maintain proper spacing of the cable package within the cable loop. The larger diameter power cables (e.g. 4 x 50) are clamped in the upper window; all other cables are guided in the lower windows and can move freely. The arrangement of the cable package must fit properly within the respective clamping window.

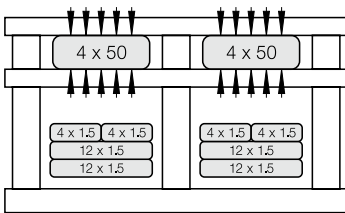

Clamping of shielded (screened) cables should be avoided.



Arrangement of round cables on the cable support

The diameters of the round cables should not vary too much in order to allow proper clamping onto the cable support.

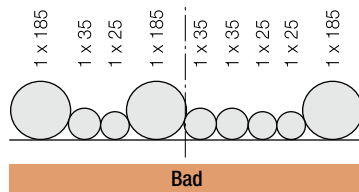
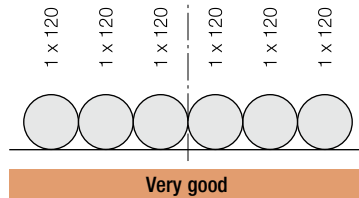

If deviations in diameters of adjacent cables are more than 15 mm use additional clamping pieces for a proper clamping.

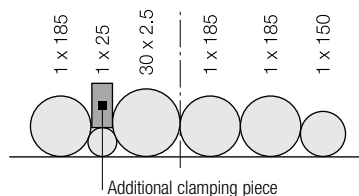

Arrangement of round cables within the cable clamp

Cable clamps maintain proper spacing of the cable package within the cable loop. The outer cables are clamped; all other cables are guided in the inner windows and can move freely.

Unshielded power cables with larger copper cross sections should be favored for the outer cables (e.g. 1 x 120 or 4 x 25).

Additional spacers can be installed in the cable clamp to avoid overlapping of cables when there are large differences in diameter.

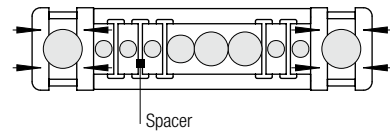

Applies for all cables: Make sure to balance the cable load on the cable support.

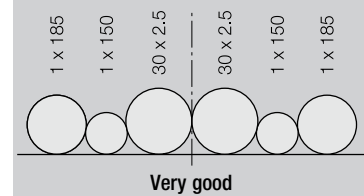

Layout Step 2

Cable Trolley Selection

1 ■ Determine the cable trolley load (F_{LW})

The approximate cable trolley load (F_{LW}) is determined with the following formula:

$$F_{LW} = 2 \times h \times G_L$$

F_{LW} = cable trolley load in kg
 h = cable loop depth in m
 G_L = cable package weight in kg/m

2 ■ Select the main roller size

Once the approximate cable trolley load (F_{LW}) is determined, the required main roller size can be selected from the following table. The material for the roller is chosen based on operating conditions:

Specification	Material
Standard	Rollers made of hardened steel
- For low noise emission and low beam wear - In tropical or subtropical climate	Hydrolysis resistant rollers with polyurethane wheels

Main rollers with steel wheels	Travel speed v in m/min							
	up to 63	80	100	125	160	200	250	300
\emptyset in mm	Permissible cable trolley load F_{LW} in kg							
40	40	36	32					
50	75	68	60	51				
63	125	110	95	85	75			
80	220	190	162	142	125	110		
100	355	305	265	230	200	185	160	
125	590	550	500	450	410	380	350	310
160	1150	1090	1050	1015	990	970	950	925

Duty Cycle : ~16h / day
 Ambient temperature : -30 °C ... +80 °C

Main rollers with polyurethane wheels	Travel speed v in m/min							
	up to 63	80	100	125	160	200	250	300
\emptyset in mm	Permissible cable trolley load F_{LW} in kg							
40	30	28	25					
50	60	53	47	42				
63	110	98	90	80	70			
80	195	170	155	135	115	100		
100	325	280	250	215	185	165	140	
112	430	395	360	330	305	275	250	210
125	540	515	460	410	380	350	320	290
160	840	795	750	705	660	615	570	505

Duty Cycle : ~16h / day
 Ambient temperature : -30 °C ... +50 °C

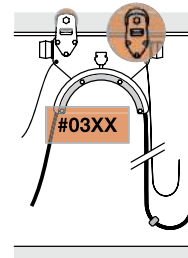

3 ■ Determine the cable trolley series

With the size of the main roller selected, the suitable cable trolley program and the possible chassis types can be determined from the following table:

Main rollers Ø in mm	V _{max} in m/min	Type of cable	Program	Possible chassis types	
				Track beam	
				Parallel flange	Tapered flange
40	50	flat/round	0314	S	S
40	75	flat	0315	-	H
40	100	flat/round	0320	S, SG	H, HG, S, SG
50	120	flat/round	0325	S, SG	H, HG, S, SG
63	150	flat/round	0330	S, SG	H, HG, S, SG
50/63/80/100	160	flat	0350	HF, HFG, S, SG	H, HG, HF, HFG, S, SG
50/63/80/100/112/125	160	round	0360	HF, HFG, S, SG	H, HG, HF, HFG, S, SG
100/112/125	180	round	0364	HFG	HFG
112/125	300*	round	0365	HMG, HMP	HMG, HMP
125/160	210	flat	0370	HMG, HMP	HMG, HMP
125/160	300*	round	0375	HMG, HMP	HMG, HMP
125/160	300	round	0380	HMG, HMP	-
160	300	round	0385	HMG, HMP	-

■ ■ Motorized programs highlighted in gray

Chassis type overview see next page >>>

* in combination with motorized systems

■ Minimum beam dimension

The following beam dimensions are necessary to accommodate the trolley wheel diameter.

Air gap A (between main roller and beam flange) = min. 10 mm

$$\text{Minimum beam width } b_{\min} \text{ in mm} = 2 \times \left(\frac{\text{roller-}\varnothing}{4} + r \right) + s + 10$$

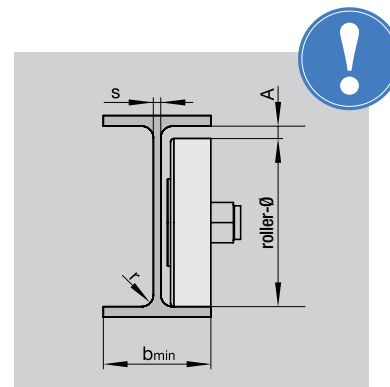

4 ■ Select the chassis type

Type
H

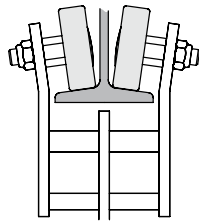

- For simple applications with low lateral forces
- Not suitable for towing trolleys

Chassis with cylindrical main rollers

Guidance of the chassis at the radius of the beam web

Guidance of the chassis	simple		optimal
Protection against tilting	low		high
Protection against lifting	low		high
Wear of beam/rollers	high		low

Standard application data

I-beam	tapered flange
Beam width max.	100 mm
Travel speed	< 120 m/min
Main roller material	steel, polyurethane

Type
HG

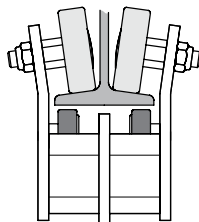

- For simple applications with low to medium lateral forces and tilting torques
- Suitable for towing trolleys

Chassis with cylindrical main rollers and anti-lift rollers

Guidance of the chassis at the radius of the beam web

Guidance of the chassis	simple		optimal
Protection against tilting	low		high
Protection against lifting	low		high
Wear of beam/rollers	high		low

Standard application data

I-beam	tapered flange
Beam width max.	100 mm
Travel speed	< 120 m/min
Main roller material	steel, polyurethane

Type
HF

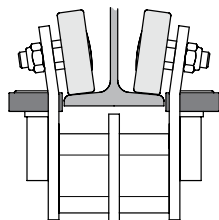

- For applications with low to medium lateral forces
- Not suitable for towing trolleys

Chassis with cylindrical main rollers and horizontal guide rollers

Guidance of the chassis at the beam flange

Guidance of the chassis	simple		optimal
Protection against tilting	low		high
Protection against lifting	low		high
Wear of beam/rollers	high		low

Standard application data

I-beam	parallel/tapered flange
Beam width max.	140 mm
Travel speed	< 150 m/min
Main roller material	steel, polyurethane

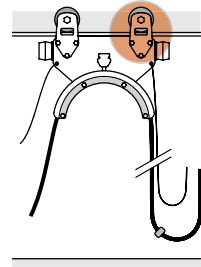

Type
HFG

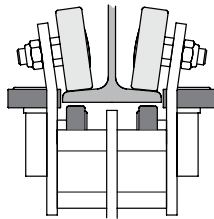

- For applications with medium to high lateral forces and tilting torques
- Suitable for towing trolleys

Chassis with cylindrical main rollers with horizontal guide rollers and anti-lift rollers

Guidance of the chassis at the beam flange

Guidance of the chassis	simple		optimal
Protection against tilting	low		high
Protection against lifting	low		high
Wear of beam/rollers	high		low

Standard application data

I-beam	parallel/tapered flange
Beam width max.	140 mm
Travel speed	< 180 m/min
Main roller material	steel, polyurethane

Type
S

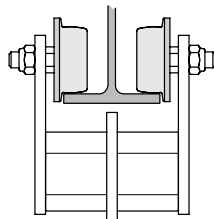

- For applications with low to medium lateral forces
- Not suitable for towing trolleys

Chassis with flanged main rollers

Guidance of the chassis at the beam flange

Guidance of the chassis	simple		optimal
Protection against tilting	low		high
Protection against lifting	low		high
Wear of beam/rollers	high		low

Standard application data

I-beam	parallel/tapered flange
Beam width max.	140 mm
Travel speed	< 80 m/min
Main roller material	steel

Type
SG

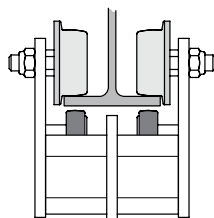

- For applications with low to medium lateral forces and tilting torques
- Suitable for towing trolleys

Chassis with flanged main rollers and anti-lift rollers

Guidance of the chassis at the beam flange

Guidance of the chassis	simple		optimal
Protection against tilting	low		high
Protection against lifting	low		high
Wear of beam/rollers	high		low

Standard application data

I-beam	parallel/tapered flange
Beam width max.	140 mm
Travel speed	< 80 m/min
Main roller material	steel

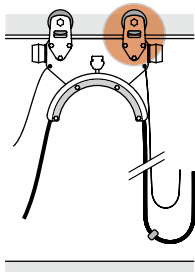

4 ■ Select the chassis type

Type
HMG

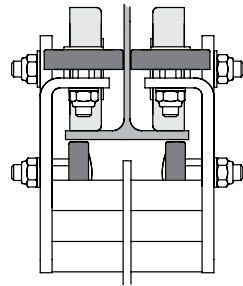

- For applications under very difficult conditions (e.g. STS container cranes)
- Suitable for towing trolleys

Chassis with cylindrical main rollers with horizontal guide rollers at the beam center web and anti-lift rollers

Guidance of the chassis at the beam center web

Guidance of the chassis	simple		optimal
Protection against tilting	low		high
Protection against lifting	low		high
Wear of beam/rollers	high		low

Standard application data

I-beam	parallel/tapered flange
Beam width max.	200 mm
Travel speed	< 300 m/min
Main roller material	polyurethane

Type
HMP

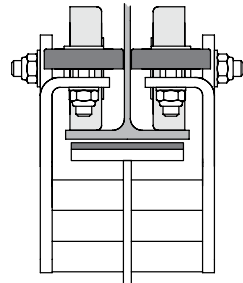

- For applications with motorized cable trolleys and heavy cable packages
- Suitable for towing trolleys

Chassis with cylindrical main rollers with horizontal guide rollers at the beam center web and anti-lift plate

Guidance of the chassis at the beam center web

Guidance of the chassis	simple		optimal
Protection against tilting	low		high
Protection against lifting	low		high
Wear of beam/rollers	high		low

Standard application data

I-beam	parallel/tapered flange
Beam width max.	200 mm
Travel speed	< 300 m/min
Main roller material	polyurethane

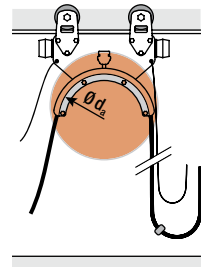

5 ■ Determine the cable support diameter

To determine the required cable support diameter d_a , calculations must be performed based on the cables being installed.

The smallest permissible cable support diameter d_a is determined on the basis of the largest cables:

	thickness of flat cable $S_{FL} \leq 12.5 \text{ mm}$	thickness of flat cable $S_{FL} \geq 12.5 \text{ mm}$	outer diameter of round cable $d_{RL} = \text{outer diameter}$
min support-Ø d_a in mm	$8 \times S_{FL}$	$10 \times S_{FL}$	$10 \times d_{RL}$

Example of calculation **flat cable**:

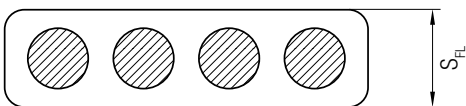

The thickness S_{FL} of the largest flat cable is 13 mm

Accordingly the minimum support diameter is:
 $d_a = 10 \times 13 \text{ mm} = 130 \text{ mm}$

Example of calculation **round cable**:

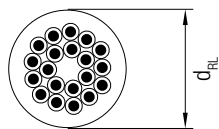

The outer diameter d_{RL} of the largest round cable is 20 mm

Accordingly the minimum support diameter is:
 $d_a = 10 \times 20 \text{ mm} = 200 \text{ mm}$

Layout Step 3

Calculate the system

1 ■ Determine the number of loops

First define the cable loop depth **h**, then choose the additional cable length factor **f** from the table below.

$$n = \frac{f \times (l_s + e)}{2 \times h + 1.25 \times d_a - f \times l_w}$$

- n = Number of loops
- l_s = Active travel in m
- f = Additional cable length factor (see table below)
- h = Cable loop depth in m
- d_a = Cable support diameter in m
- l_w = Cable trolley length in m
- e = Free space in storage distance (recommendation ≥ 0.5 m)

n determines the number of required cable trolleys:

$$\text{Number of cable trolleys} = n - 1$$



2 ■ Determination of the required storage distance from middle of end clamp to middle of towing trolley

For further calculations round up the number of loops.

$$l_b = (n-1) \times l_w + l_E + l_M + e$$

- l_b = Storage distance from middle of end clamp to middle of towing trolley in m
- n = Number of loops
- l_w = Length of cable trolley in m
- l_E = Length of end clamp in m
- l_M = Length of towing trolley/ towing clamp in m
- e = Free space in storage distance (recommendation ≥ 0.5 m)

3 ■ Determination of the cable system length from middle of end clamp to middle of towing trolley and of the order length of the cable

$$L_{\text{Syst}} = f \times (l_s + l_b)$$

$$L_{\text{Best}} = L_{\text{Syst}} + L_{\text{instE}} + L_{\text{instM}}$$

- L_{Syst} = Required cable system length from middle of end clamp to middle of towing trolley/towing clamp in m
- f = Additional cable length factor
- l_s = Active travel in m
- l_b = Storage distance in m
- L_{instE} = Installation length end clamp side in m
- L_{instM} = Installation length towing side in m
- L_{Best} = Cable order length, including installation length - in m

■ Determination of the additional cable length factor f

additional length factor f	cable loop depth h in m					
	< 0.8	0.8 - 1.2	1.3 - 2.0	2.1 - 3.2	3.3 - 5.0	5.1 - 8.0
travel speed v _{max} in m/min						
32	1.10	1.10	1.10	1.10	1.10	1.10
33 - 40	1.15	1.10	1.10	1.10	1.10	1.10
41 - 50	1.20	1.15	1.10	1.10	1.10	1.10
51 - 63	1.25	1.20	1.15	1.10	1.10	1.10
64 - 80		1.25	1.20	1.15	1.10	1.10
81 - 100			1.25	1.20	1.15	1.10
101 - 125				1.25	1.20	1.15
126 - 160				1.25	1.25	1.20
161 - 200				1.25	1.25	1.25
201 - 250				1.25	1.25	1.25
251 - 300				1.25	1.25	1.25

■ ■ For the cells highlighted in orange we recommend the use of damping devices or motorized systems to stabilize the cable loops.

■ ■ Motorized programs highlighted in gray.

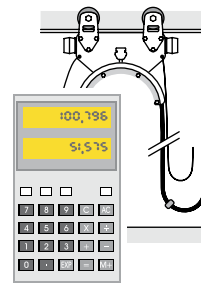

4 ■ Determine the actual cable loop

$$h = \frac{L_{\text{Syst}}}{2 \times n} - (0.63 \times d_a)$$

h = Cable loop depth

L_{Syst} = Required cable system length measured from middle of end clamp to middle of towing trolley or towing clamp in m

d_a = Cable support diameter in m

n = Number of loops

5 ■ Determine the towing rope lengths

$$L_{\text{Zug}} = 0.95 \times \frac{L_{\text{Syst}}}{n} - (k + 0.084)$$

For travel speeds higher than 50 m/min, we recommend the use of towing ropes.

Please take the dimension k for the towing rope fixation from the respective cable trolley program.

6 ■ Select damping device

$$L_{\text{Gum}} = \frac{L_{\text{Zug}}}{1.5}$$

L_{Gum} = Shock cord length in m

L_{Zug} = Towing rope length in m

The selection of the correct damping device (quantity and diameter of the shock cords) depends on the application.

– Please contact us –



Symbols and units

b_1	mm	Cable trolley width
b_2	mm	Max. permissible clamping width
c_E	m, mm	Beam clearance end clamp side
c_M	m, mm	Beam clearance towing side
d_a	mm	Cable support diameter
d_{RL}	mm	Outer diameter round cable
e	m, mm	Free space within the storage distance
f		Additional cable factor length
F_{LW}	kg	Cable trolley load
G_L	kg/m	Cable package weight
h	m, mm	Cable loop depth
h_a	m, mm	Cable trolley height from lower edge of beam to upper edge of cable support
h_{ges}	m	Cable loop depth from lower edge of beam to loop bottom
k	m, mm	Drill hole distance for towing rope connection
l_b	m	Cable trolley storage including free space (e)
L_{Best}	m	Cable order length
l_E	m, mm	End clamp length
l_{ges}	m	Track beam length
L_{Gum}	m	Shock cord length
L_{instE}	m	Installation length end clamp side
L_{instM}	m	Installation length towing side
l_K	m, mm	Towing clamp length
l_M	m, mm	Towing trolley length
l_{MF}	m, mm	Distance from middle of towing trolley to middle of towing window
l_s	m	Active travel (e.g. main trolley or crane travel)
L_{Syst}	m	Cable system length
l_W	m, mm	Cable trolley length
L_{Zug}	m	Towing rope length
n		Number of loops
s	mm	Clamping height at the cable trolley
s_{FL}	mm	Thickness of flat cable
v	m/s, m/min	Travel speed

Your Applications – our Solutions

Festoon Systems from Conductix-Wampfler represent only one of the many solutions made possible by the broad spectrum of Conductix-Wampfler components for the transport of energy, data and fluid media. The solutions we deliver for your applications are based on your specific requirements. In many cases, a combination of several different Conductix-Wampfler systems can prove advantageous. You can count on all of Conductix-Wampfler's Business Units for hands-on engineering support – coupled with the perfect solution to meet your energy management and control needs.



Cable Reels

Motorized reels and spring reels by Conductix-Wampfler hold their own wherever energy, data and media have to cover the most diverse distances within a short amount of time – in all directions, fast and safe.



Festoon Systems

It's hard to imagine Conductix-Wampfler cable trolleys not being used in virtually every industrial application. They're reliable and robust and available in an enormous variety of dimensions and designs.



Conductor Rails

Whether they're enclosed conductor rails or expandable single-pole systems, the proven conductor rails by Conductix-Wampfler reliably move people and material.



Non-insulated Conductor Rails

Extremely robust, non-insulated conductor rails with copper heads or stainless steel surfaces provide the ideal basis for rough applications, for example in steel mills or shipyards.



Energy Guiding Chains

The "Jack of all trades" when it comes to transferring energy, data, air and fluid hoses. With their wide range, these energy guiding chains are the ideal solution for many industrial applications.



Slip Ring Assemblies

Whenever things are really "moving in circles", the proven slip ring assemblies by Conductix-Wampfler ensure the flawless transfer of energy and data. Here, everything revolves around flexibility and reliability!



Inductive Power Transfer IPT®

The no-contact system for transferring energy and data. For all tasks that depend on high speeds and absolute resistance to wear.



Reels, Retractors and Balancers

Whether for hoses or cables, as classical reels or high-precision positioning aids for tools, our range of reels and spring balancers take the load off your shoulders.



Jib Booms

Complete with tool transporters, reels, or an entire media supply system – here, safety and flexibility are key to the completion of difficult tasks.

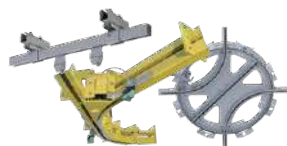

Conveyor Systems

Whether manual, semiautomatic or with Power & Free – flexibility is achieved with full customization concerning layout and location.

www.conductix.com

Conductix-Wampfler

has just one critical mission:

To provide you with energy and data transmission systems that will keep your operations up and running 24/7/365.

To contact your nearest sales office, please refer to:

[www.conductix.com/
contact-search](http://www.conductix.com/contact-search)



Ⓞ DELACHAUX GROUP