

# Product Overview

## Conductix-Wampfler Cables

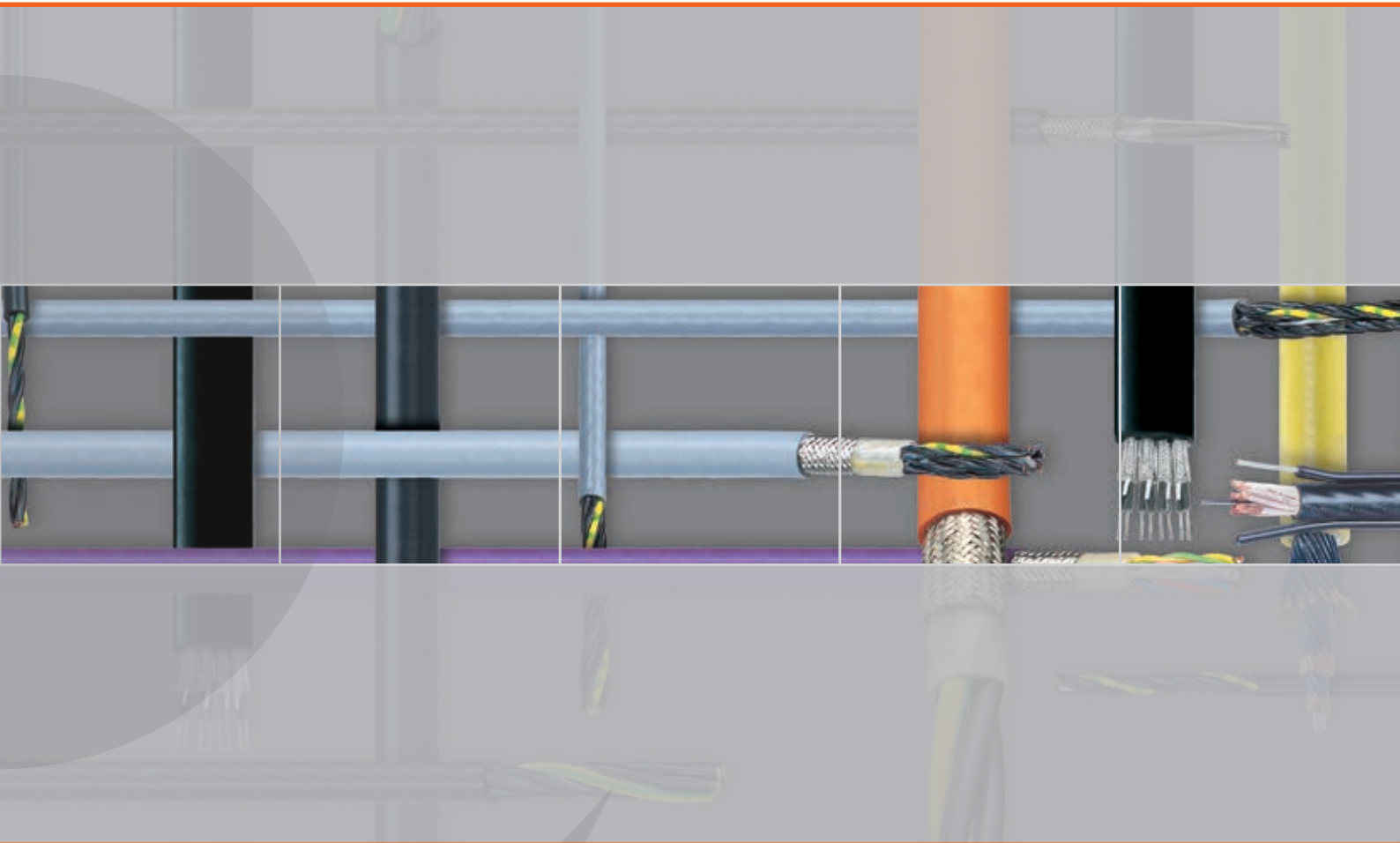

**CONDUCTIX**  
wampfler

Ⓞ DELACHAUX GROUP





# Cables for systems in motion selected from experts



## Advantage 1 Secure choice of cables

- Comprehension of our customers applications and needs is the foundation of our choice. We offer the complete package with systems and cables that match perfectly to your application.

## Advantage 2 System compatibility

- The cable design significantly influences the performance of the energy and/or data supply system – we ensure the proper alignment of the cable to the system for optimized energy and data transfer.

## Advantage 3 Manufacturer independence

- The performance of the cable is more important to us than its origin – we neutrally select only the most technically qualified cables available on the market. Additionally we conduct our own test scenarios on our systems to ensure best functionality.

## Advantage 4 System guarantee

- Each complete Conductix-Wampfler system is provided with a comprehensive guarantee – this, needless to say, includes the cable.

## Advantage 5 Conductix-Wampfler cable service



- Conductix-Wampfler services ensure the reliability of our energy supply systems and the availability of our customers equipment.

## Contents

• Cables-Overview   At a glance	4
• Cables for Festoon Systems	7
• Cables for Cable Chains	9
• Cables for Reeling Systems	11
• Customized Cable Service	13
• Questionnaire Cables	14











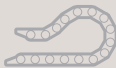









# At a glance

## The right cable for every application

Application												
	Basic Reeling Systems						Heavy Duty Reeling Systems					
Power / Control												
	MALT	GPM	RP	RG	WG	WGF	C800	GPM-RF	RXP	RXG	TRA	HVR
Composite Power + Control + Data												
			RP-D	RG-D	WG-D	WGF-D			RXP-D	RXG-D		HVR-FO
Label respectively Design	Conductix-Wampfler	Conductix-Wampfler	12YRDT11YH	NSHTOEU-J	Conductix-Wampfler	(N)TSFLGEOEU	Conductix-Wampfler	Conductix-Wampfler	12YHRDT11YH	(N)SHTOEU-J	Conductix-Wampfler	Conductix-Wampfler
Outer jacket material	PVC	PUR	PUR	Rubber	Rubber	Rubber	PVC	PUR	PUR	Rubber	PUR	Rubber
Suitable for use outdoors	●	●	●	●	●	●	●	●	●	●	●	●
Voltage range	0.6/1 kV	0.6/1 kV	up to 0.6/1 kV	0.6/1 kV	3.6/6 kV up to 12/20 kV	3.6/6 kV up to 12/20 kV	0.6/1 kV	0.6/1 kV	up to 0.6/1 kV	0.6/1 kV	0.6/1 kV	3.6/6 kV up to 12/20 kV
Tensile load capacity max. [N / mm <sup>2</sup> ]	10	12	15	15	20	15	20	20	25	30	30	20
Travel speed max. [m / min]	40	60	80	120	120	120	60	60	180	240	200	180
Temperature range flexing [°C]	-20	-25	-20	-25	-25	-25	-10	-25	-40	-35 <sup>(1)</sup>	-25	-30 <sup>(2)</sup>
	up to 60	up to 60	up to 70	up to 80	up to 80	up to 80	up to 60	up to 60	up to 80	up to 60	up to 80	up to 80

<sup>(1)</sup> -45 °C on request    <sup>(2)</sup> -45 °C on request

<b>Specialities</b>	- Special cables with compounds for low temperature environments down to -50°C available on request
	- Special cables with compounds and protection for very high temperatures up to 180°C available on request
	- Specific cables for use in all kinds of water (e.g. drinking, waste water etc.) are available on request

											
Extra Heavy Duty Reeling Systems			Basic Festoon		Heavy Duty Festoon			Heavy Duty Chain	Specials		
WXG	RXX	TRA-RF	FV	TG	FXG	TXP	TXG	CXP	PV	SXP	SXG
											
											
(N)TSKGEWOEU	(N)SHTOEU-J	Conductix-Wampfler	H05WH6-F YCFLY H07WH6-F YFELY / YFCY	H07RN-F	NGFLGOEU-J (UL) (N)GLFGOEU-J (UL) M(SD)HOEU (UL) GCFLGOEU	12YHRD11YH 12YHRDC11YH	(N)GRDGOEU-J/O (N)GRDGGOEU-J/O (N)3GRD5G (N)3GRDGC5G	12YMSL11Y 13YMSL13Y	MITTY-O FMYTW	YSLTOE-J/O YSLZ3S0E-J	NTMCWOEU
Rubber	Rubber	PUR	PVC	Rubber	Rubber	PUR	Rubber	PUR / TPE	PVC	PUR	Rubber
●	●	●	●	●	●	●	●	●	●	●	●
3.6/6 kV up to 12/20 kV	0.6/1 kV	0.6/1 kV	up to 450/750 V	up to 450/750 V	up to 0.6/1 kV	up to 0.6/1 kV	up to 0.6/1 kV	up to 0.6/1 kV	mV up to 35 kV	mV up to 0.6/1 kV	mV up to 35 kV
20	30+	30+	15	15	15	15	15 up to 20	15	15 up to 30	15 up to 30	15
300	240 *	240	120	80	180	210	240	up to 300	various	various	-
-35	-35	-25	-25	-30	-35	-30	-35	-35	various	various	-25
up to 80	up to 80	up to 60	up to 60	up to 60	up to 80	up to 90	up to 80	up to 80			up to 80

\* up to 300 m/min ● ideal ● limited





- FV
- FV-D
- TG
- FXG
- FXG-D
- TXP
- TXP-D
- TXG
- TXG-D

# Conductix-Wampfler Cables for Festoon Systems

## Special features of cables for Festoon Systems

- Low weight and small diameter due to a stranded layered conception. In the case of power cables, the earth conductor is split into three conductors.
- Resistant to alternating bending loads due to finely stranded conductors
- Sheathing compounds with very high resistance to outdoor atmospheric conditions
- Notch-resistant sheathing compounds with high resistance to tearing, highly resistant to stress caused by continuous bending at the bottom of the loop
- Robust outer sheath designed to absorb impact forces
- High axial rigidity and resilience due to pressure filled extrusion in interstices
- Highly resilient cables allow the smallest possible bending radius and therefore, short system lengths

## Prominent places of particular impacts

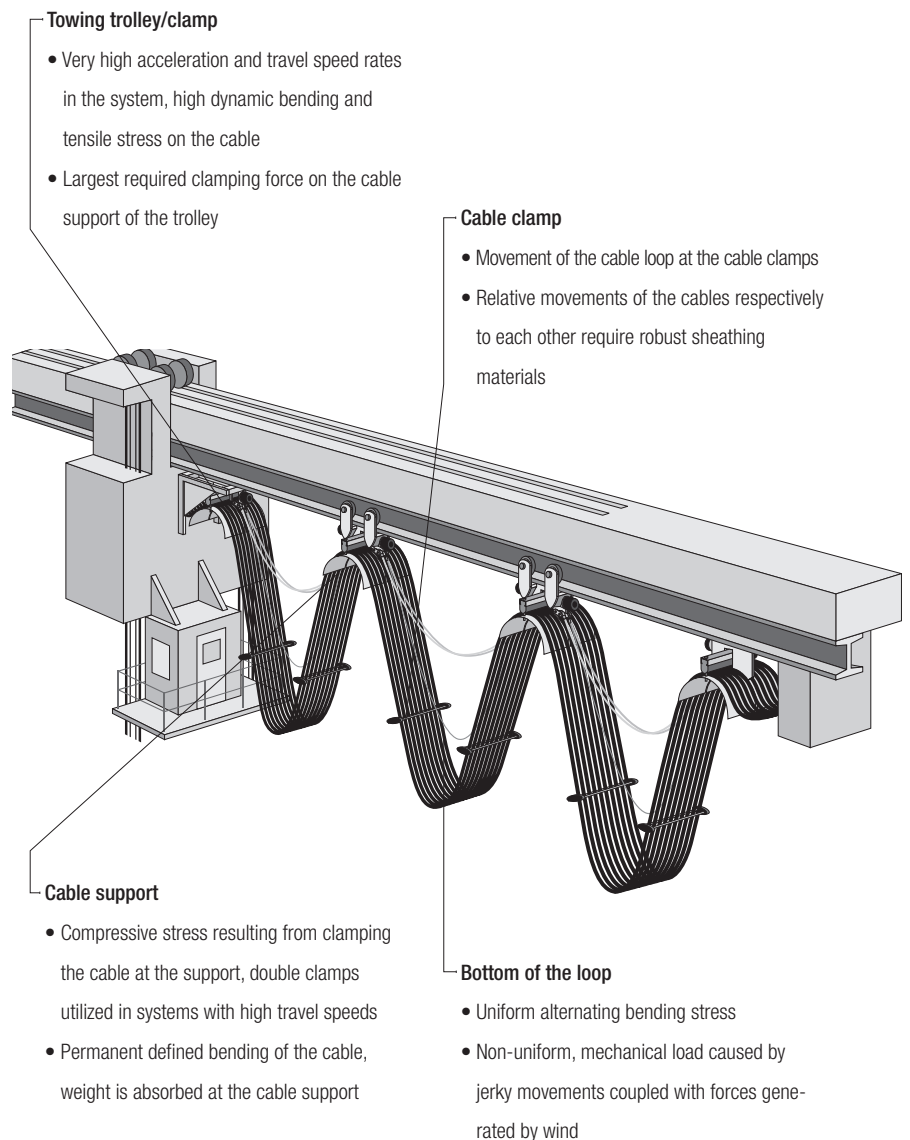



CXP  
CXP-D

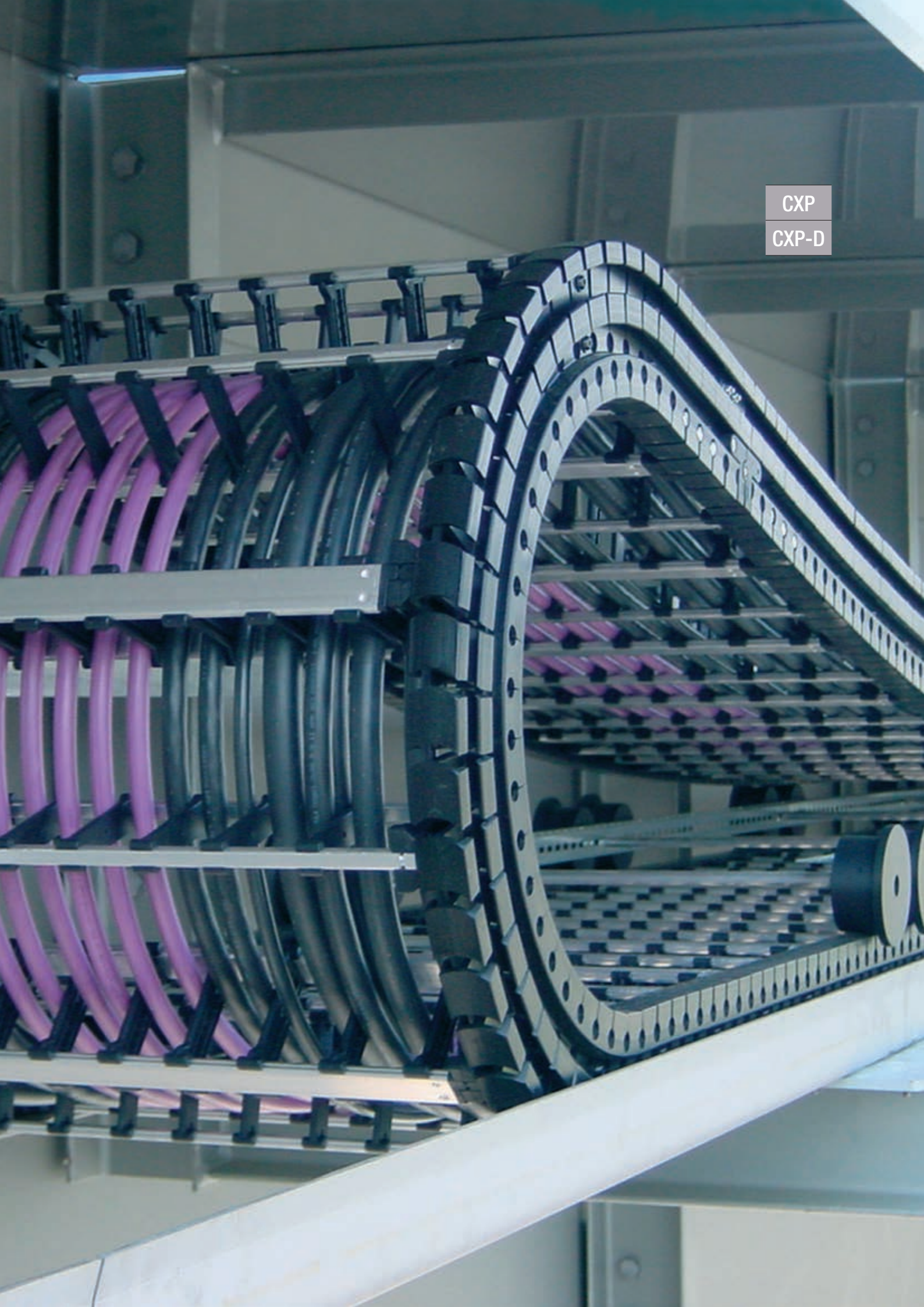



# Conductix-Wampfler Cables for Energy Guiding Chains

## Special features of cables for Energy Guiding Chains

- Low weight and small diameters as a result of particularly thin conductor insulation and sheaths
- Best insulation materials for small wall thickness
- Very high resilience due to short lay pitches (7 to 8 x Ø)
- Flexible sheath compound with high resistance to tearing and abrasion
- Resistance to corkscrews as a result of a stranding with reverse twist
- Extruded filler in interstices provides stable construction
- High wear resistance against chain material

## Prominent places of particular impacts

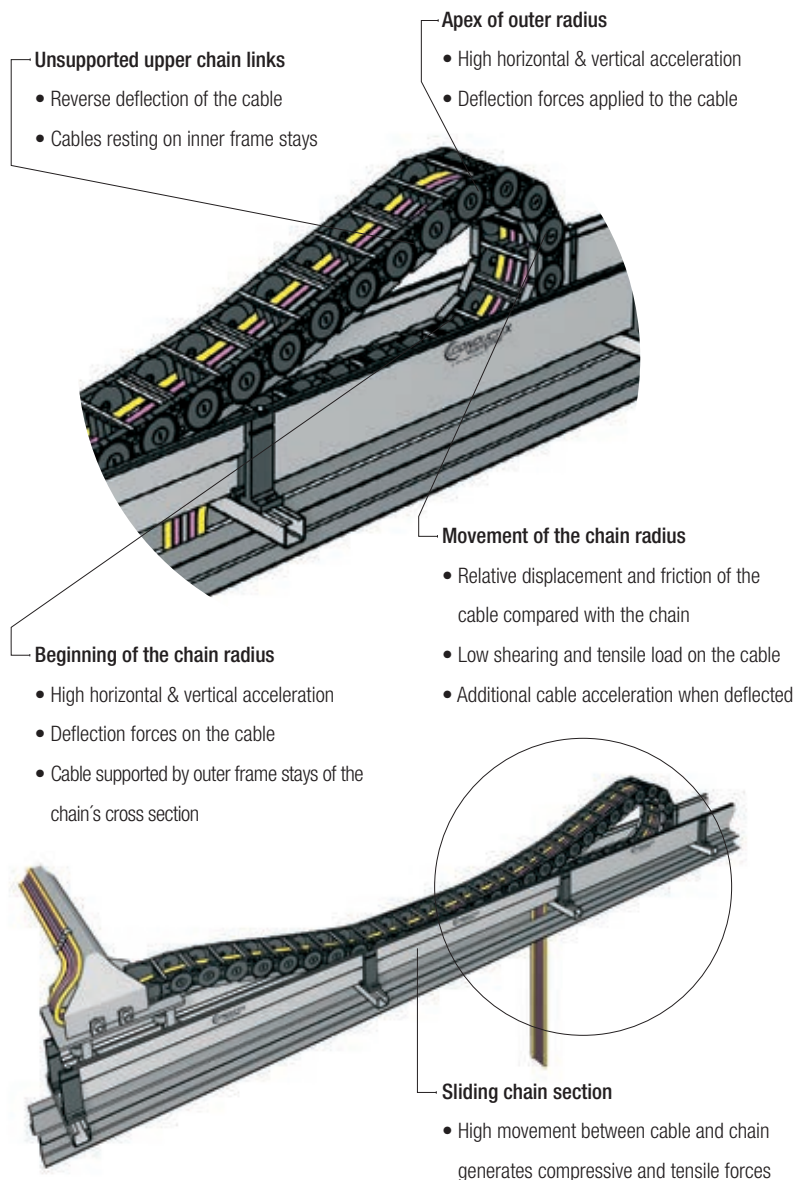



- MALT
- GPM
- RP
- RP-D
- RG
- RG-D
- WG
- WG-D
- WGF
- WGF-D
- C800
- GPM-RF
- RXP
- RXP-D
- RXG
- RXG-D
- TRA
- HVR
- HVR-D
- WXG
- WXG-D
- RXX
- TRA-RF



# Conductix-Wampfler Cables for Reeling Systems

## Special features of cables for Reeling Systems

- Reduced diameter and weight as a result of ideal insulation and sheathing materials
- Better resistance to corkscrew due to reverse twist stranding
- Stable construction and geometry based on extruded fillers
- Outer sheath is highly resistant to wear even in aggressive environments
- Extremely high resilience thanks to a very short lay stranding
- High axial rigidity due to interlinked inner and outer sheaths
- All high voltage cables are produced with left-hand lay

## Specialities (available on request)

- Composite cables with power + control + fibre optics
- Cables with compounds for low temperature environments down to -50°C
- Cables with compounds and protection for very high temperatures up to 180°C
- Cables suitable for use in all kinds of water (e.g. drinking water, waste water etc.).

## Prominent places of particular impacts

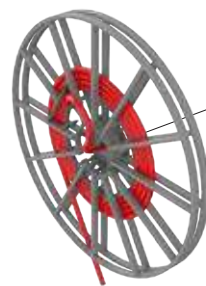

### Monospiral winding reel

- High tensile loads can occur during winding
- Torsional stresses through the use of guiding pulleys
- High speed in combination with changing bending direction
- Reverse bending "S-type" due to mid feeding point
- Abrasion through the inner spokes of the drum body
- Temperature drops effect the cable jacket rigidity

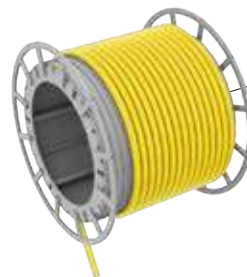

### Spreader winding reel

- Very high tensile load from vertical pull
- The metal cleaves on the drum body may lead to abrasion
- Cable must withstand oil and grease
- Temperature drops effect the cable jacket rigidity

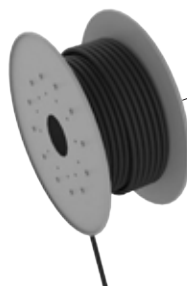

### Random winding reel

- Random winding on the drum
- Smaller bending radii stress the copper conductors which need to be flexible

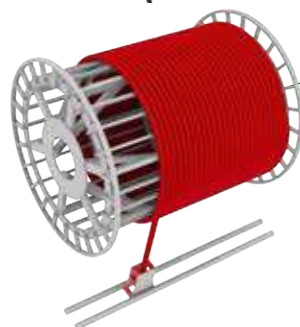

### Level winding reel

- Torsion to the cable through the use of a special guiding device
- Bending via the special guiding device
- Winding of one layer has to be exact over the large width of the reel body
- Extreme ambient influences on the jacket (e.g. UV, ozone, coal dust, graphite)
- Max 2 layers on drum body because of heat emanation





# Customized Service

## Expertise

The breadth and depth of Conductix-Wampfler's service is geared to the requirements and desires of our customers. The service varies from consulting and project planning to long-term service contracts for complete systems for energy and data transfer.

## Project planning

- Selection of suitable cables considering the installation and environmental requirements
- Calculation of our cables' ampacity for the respective application on request
- Complete selection of cables compatible with the specific system for energy and data transfer: correct cable lengths, physical dimensions, bending radii and tensile loads



## Pre-assembly

- Assembly of cable packages onto cable-trolley systems; shipment on C-rails or I-beams for easier and faster final assembly
- Assembly of cables onto spring and motorized cable reels; shipment of complete assembly with cables connected to the slip rings
- Complete assembly of cable chain with cables; strain-reliefs optionally pre-assembled, shipments on special plug&play transport and assembly racks or wooden transport drums

## Final assembly

- Complete installation as well as start-up operation carried out by trained and qualified personnel
- Acceptance together with the customer
- On site instruction and training

## Inspection & Servicing

- Regular inspections of the facility coupled with expert service, increase the availability and reliability of every system



# Questionnaire | Specification Data

## Cables

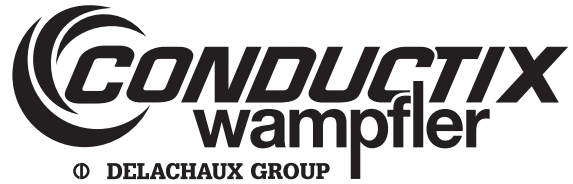

### Technical datas

On which energy transmission system is the cable used?  Festoon System  Reel  Energy Guiding Chain

		Cable 1	Cable 2	Cable 3	Cable 4	Cable 5
Cable Designation						
Number of cores						
Cross section [mm <sup>2</sup> ]						
Length [m/ piece]						
Piece						
Cable type	flat					
	round					
Sheath Material	rubber					
	PVC					
	PUR					
	others					
Earth conductor	yes					
	no					
Screen	yes					
	no					

Is a combined solution preferred?  yes  no  
 if yes:  Power + Control  Power + Control + Data (FO)  Power + Data (FO)

### Application Data

- Travel speed: \_\_\_\_\_ [m/min]
- Acceleration: \_\_\_\_\_ [m/s<sup>2</sup>]
- Max. perm. operating temperature of the conductor: \_\_\_\_\_ [°C]
- Ambient temperature: \_\_\_\_\_ [°C]  
 in operation: from \_\_\_\_\_ [°C] to \_\_\_\_\_ [°C]  
 static: from \_\_\_\_\_ [°C] to \_\_\_\_\_ [°C]
- Other special conditions concerning the installation [e.g. cable guide]: \_\_\_\_\_
- Inrush current / max. power: \_\_\_\_\_ / \_\_\_\_\_ [kVA] / 100% DC
- Rated voltage: U<sub>0</sub> / U: \_\_\_\_\_ / \_\_\_\_\_ [kV]
- Bending radius: \_\_\_\_\_ [mm]
- Tensile load: \_\_\_\_\_ [N]
- Installation:  Horizontal  Vertical  Fixed installation  
 Connecting to: \_\_\_\_\_

### Data transfer | Screen | FO

- Profi Bus  CAN-Bus  Industrial - Ethernet  Others
- What data has to be transferred?: \_\_\_\_\_
- Screen specification:  Overall screen  Pairs  Individual  
 FO, fiber type:  50/125μ  62,5/125μ  E9/125μ
- Required data transfer rate: \_\_\_\_\_ [MBit/s]
- Number of fibers:  6  12  18  24

### Operating Conditions

- Site:  Indoors  Outdoors  Port  Tropics  Subtropics
- Degree of pollution:  Little  Medium  Strong
- Aggressive media:  Yes  No  
 Type: \_\_\_\_\_  
 Concentration: \_\_\_\_\_
- Ambient Temperature: min. \_\_\_\_\_ [°C] max. \_\_\_\_\_ [°C]
- Humidity: \_\_\_\_\_ [%]
- Perm. wind speed during crane operation: \_\_\_\_\_ [m/s]
- Special chemical influences, e.g.  
 Phosphates  Sulphur  Urea
- Other influences, e.g.  Heavy pollution  
 Type of pollution: \_\_\_\_\_
- Humidity  Wetness  Dust  
 if yes, which type?  Corrosive  Not corrosive
- Very hot: \_\_\_\_\_ °C  Very cold: \_\_\_\_\_ °C



# Your Applications – our Solutions

Cables from Conductix-Wampfler represent only one of the many solutions made possible by the broad spectrum of Conductix-Wampfler components for the transport of energy, data and fluid media. The solutions we deliver for your applications are based on your specific requirements. In many cases, a combination of several different Conductix-Wampfler systems can prove advantageous. You can count on all of Conductix-Wampfler's Business Units for hands-on engineering support – coupled with the perfect solution to meet your energy management and control needs.



## Festoon systems

It's hard to imagine Conductix-Wampfler cable trolleys not being used in virtually every industrial application. They're reliable and robust and available in an enormous variety of dimensions and designs.

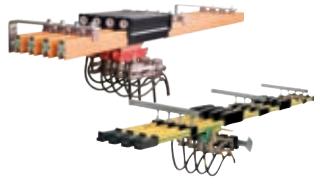

## Conductor rails

Whether they're enclosed conductor rails or expandable single-pole systems, the proven conductor rails by Conductix-Wampfler reliably move people and material.



## Non-insulated conductor rails

Extremely robust, non-insulated conductor rails with copper heads or stainless steel surfaces provide the ideal basis for rough applications, for example in steel mills or shipyards.



## Slip ring assemblies

Whenever things are really "moving in circles", the proven slip ring assemblies by Conductix-Wampfler ensure the flawless transfer of energy and data. Here, everything revolves around flexibility and reliability!



## Motorized Cable & Hose Reels

Motorized reels by Conductix-Wampfler hold their own wherever energy, data, media and fluids have to cover the most diverse distances within a short amount of time – in all directions, fast and safe.



## Spring Cable & Hose Reels

With their robust and efficient design Spring Cable and Hose Reels from Conductix-Wampfler are unbeatably reliable in supplying energy, signals, data and fluids to a vast range of tools, cranes and vehicles.



## Inductive Power Transfer IPT®

The no-contact system for transferring energy and data. For all tasks that depend on high speeds and absolute resistance to wear.



## Retractors and Balancers

Our wide range of high reliable retractors and balancers remove the load from your shoulders and allow you to reach top productivity.



## Energy guiding chains

The "Jack of all trades" when it comes to transferring energy, data, air and fluid hoses. With their wide range, these energy guiding chains are the ideal solution for many industrial applications.



## Jib booms

Complete with tool transporters, reels, or an entire media supply system – here, safety and flexibility are key to the completion of difficult tasks.



## Conveyor systems

Whether manual, semiautomatic or with Power & Free – flexibility is achieved with full customization concerning layout and location.

# www.conductix.com

## **Conductix-Wampfler**

has just one critical mission:

To provide you with energy and data transmission systems that will keep your operations up and running 24/7/365.

To contact your nearest sales office, please refer to:

**[www.conductix.com/  
contact-search](http://www.conductix.com/contact-search)**

