

Motor Driven Reels

MAG Drive



CONDUCTIX
wampfler
© DELACHAUX GROUP



60t

P3

Motor driven reels with MAG Drive

The reliable magnetic coupler solution

Wherever goods and people are in motion, you will find motor driven reels designed and built by Conductix-Wampfler. If you need to manage critical power cables, data cables, air hoses, or fluid hoses, motor driven reels with **MAG Drive** are the right solution.

For the management of low voltage and high voltage cables or hoses, Conductix-Wampfler motor driven reels with **MAG Drive** cater to all kinds of harsh applications.

At bulk ports, steel mills, theaters, waste water treatment plants, and mines, our **MAG Drive** reels reliably handle demanding requirements, especially in harsh environmental conditions.

Installation on-site can be completed quickly and periodic maintenance is fast and easy. During their lifetime, Conductix-Wampfler motor driven reels with **MAG Drive** will minimize your total cost of ownership.

Conductix-Wampfler offers a complete package of services to you. In addition to the delivery of the motorized reel, we offer qualified project consulting, complete system engineering services, selection of the right cable, and a full array of accessories.

Management of project logistics and on-site commissioning are important services we provide for you.

Thus, energy and data signals reach your machinery safely and reliably, wherever they are required.

Conductix-Wampfler provides service before and after the sale from our global network of sales offices. We support you - worldwide!



24/7 operation in demanding environments such as bulk material handling

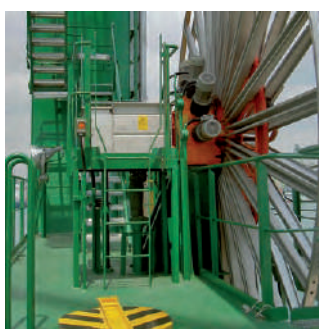

Everything from one source!
The right cable is always recommended.

Magnetic coupler

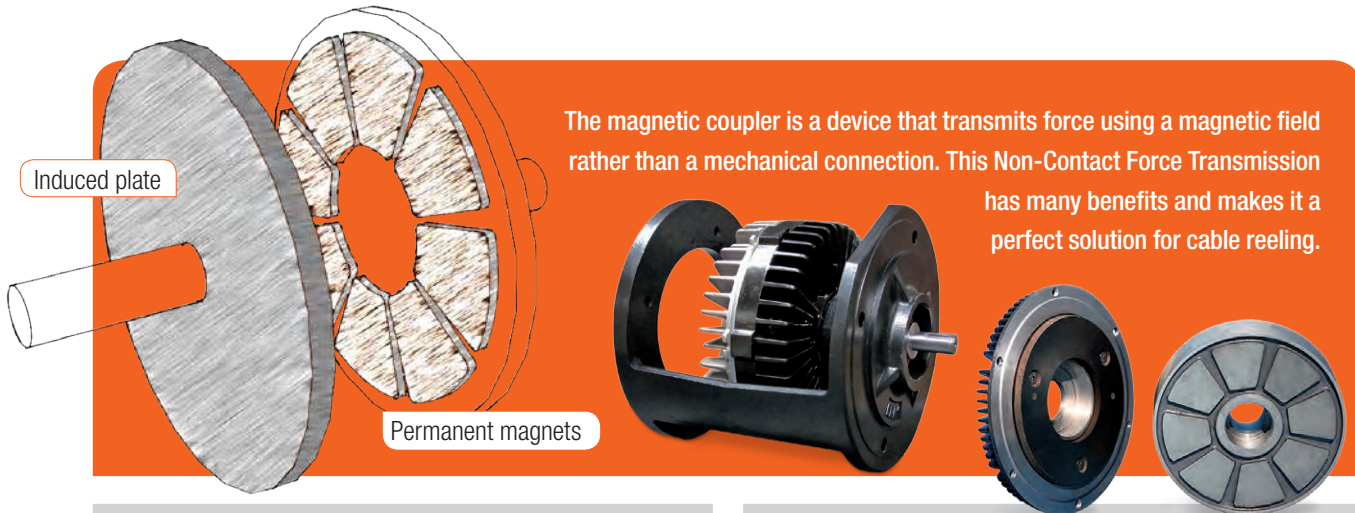

The magnetic coupler is a device that transmits force using a magnetic field rather than a mechanical connection. This Non-Contact Force Transmission has many benefits and makes it a perfect solution for cable reeling.

Advantages of Conductix-Wampfler MAG Drive

- Optimized design for maximum magnetic hysteresis :
 - High efficiency and low energy consumption
 - Smooth constant torque to ensure long cable life
- No contact: no friction, no oil, no maintenance
- No loss of cable tension during power failures
- Rugged built with high durability materials
- Most reliable magnetic coupler on the market

Environmental and Operating Considerations

- The Conductix-Wampfler magnetic coupler is completely sealed water and dust proof
- Operates in any position
- Suitable for seaside conditions and exposure to sea waves
- Suitable for hazardous environments (up to AtEx 22)
- Works in ambient temperatures from -40°C up to +70°C

Design

Each Conductix-Wampfler magnetic coupler is assembled from key carefully matched components:

The induced plate is machined from a special hardened magnetic steel ring. Its specific design maximizes the Conductix-Wampfler magnetic coupler yield and reduces energy consumption.

The permanent magnet plate features very high magnetic strength TiCoNiAl magnets mounted with alternate polarity. Their very high Curie point allows high speed / high temperature continuous operation.

The housing supports both induced and permanent magnet plates. The oversized fins efficiently evacuate the heat even in high ambient temperature for high reliability. The threaded design allows to easily tune the torque on-site for fine adjustment to the application.

The high quality bearings used allow to maintain constantly a very small airgap between the magnetic plates, allowing both high yield and no friction operation for very long lifetime.

Constant torque generation

The permanent magnets magnetize the induced plate, thus generating a ring of alternating polarity magnetic domains. The rotating magnetic field pulls the magnetic domains around the induced plate. The domains motion is constrained by the material hysteresis as if they were moving in a fluid.

This contactless interaction generates a very constant torque within a wide range of speed difference between input and output (300 to 3000 rpm ca). This is a formidable advantage of CxW MAG Coupler vs torque motors, hydrodynamic couplers, friction clutches and competitors' magnetic couplers.

Operating Principle

- **Winding of cable**

The induced plate rotates at the speed of the electric motor. The permanent magnet is then driven by the magnetic forces and the spool will wind the cable at a rate that matches the speed of the mobile machine.

- **Unwinding of cable**

The induced plate always turns in the winding direction at the output speed of the electric motor. The permanent magnet which is connected to the spool shaft rotates in the opposite direction.

The electric motor always turns in the same direction regardless of the direction of the spool rotation.

- **Power off**

When the equipment is switched off, the backward rotation of the induced plate is blocked using a freewheel or an electric brake. The magnetic field of the permanent magnet generates torque, which prevents the cable from self-unwinding.

However, it is always possible to unwind the cable by applying a pull action stronger than the magnetic coupler torque.

Therefore, the cable (or hose) is protected even if the mobile machinery moves unintentionally (e.g. a crane pushed by the wind).

Settings

The amount of output torque generated by the coupler depends on the air gap between the induced plate and the permanent magnet. A smaller gap generates more torque, a larger gap generates less torque.

The air gap is factory pre-set for the application. However, adjustments can easily be made on-site if there are changes to the travel speed, cable, or hose.

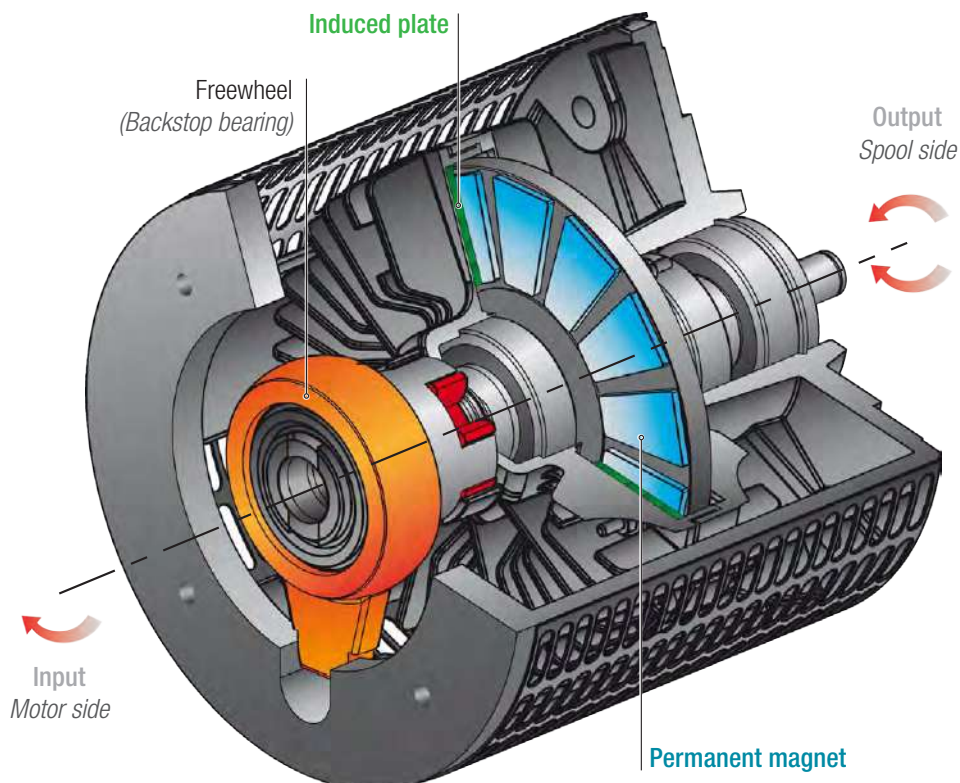



Modular Assembly System

Modular and compact design: limited number of spare parts and reduced maintenance procedures.

Reliable magnetic couplers: simple component without contact (no wear, no lubrication required).

Uses standard off-the-shelf electrical motors.

Highly efficient components and low starting inertia.

Magnetic coupler acts as a torque limiter that protects the cable and the related equipment, and increases safety for nearby personnel.

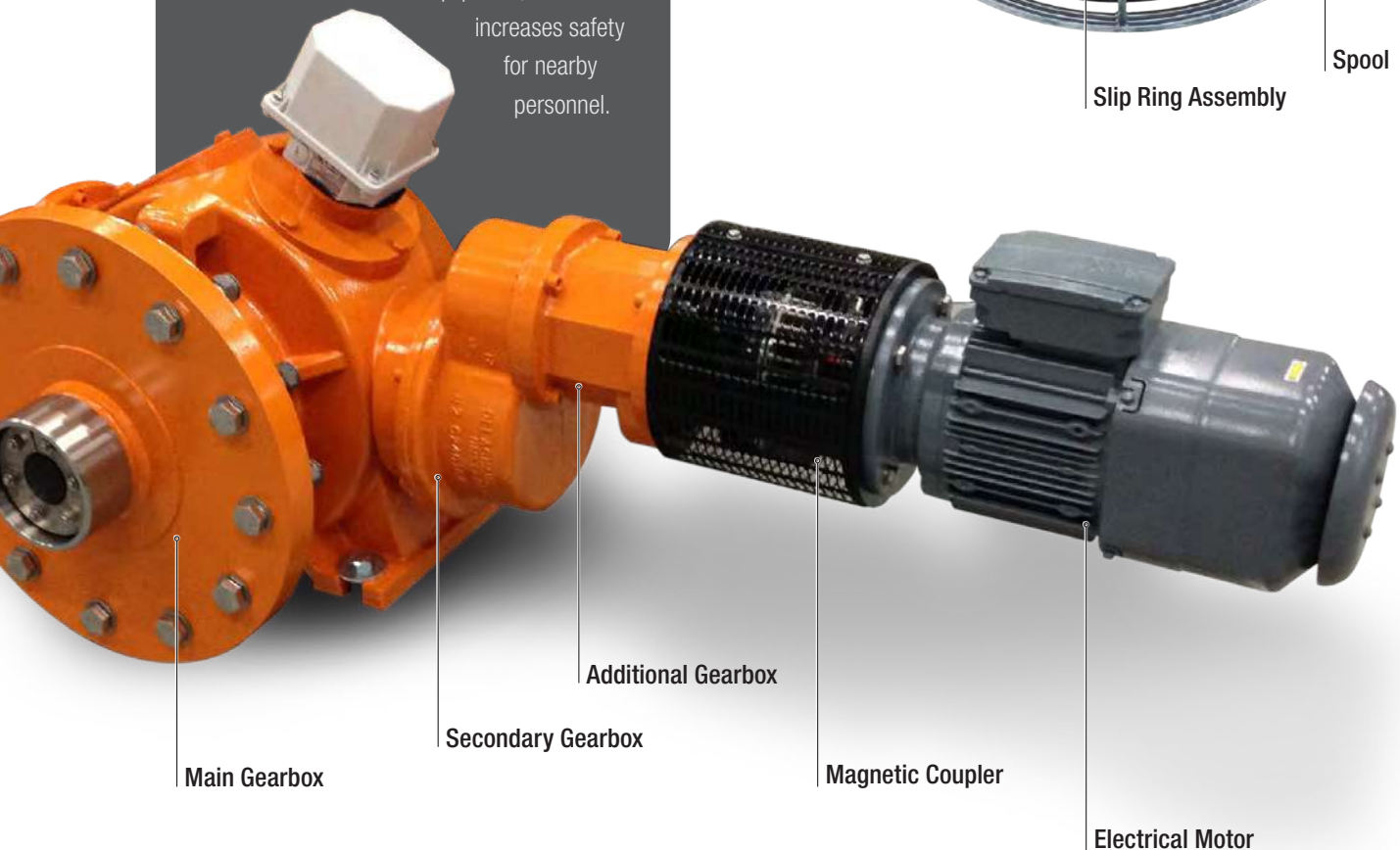

Driving Units

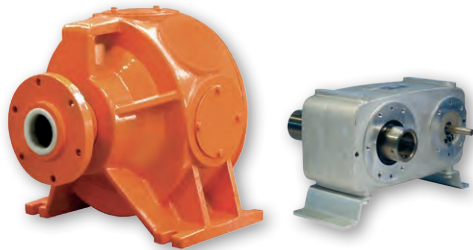

Main Gearbox

As the primary part of the reeling drum, the main gearbox carries the dynamic and static loads generated by the spool, the drive units and the slip ring assembly. Its specification is directly related to the size of the reel.

- The drive units are all mounted radial to the rotational axis of the spool.
- The main gearbox can accommodate from one up to seven magnetic couplers, depending on the model chosen.
- The slip ring assembly is normally located on the opposite side of the spool. It is easily accessible for connections and maintenance.

Secondary Gearbox & Additional Gearbox

The function of the secondary and additional gearbox is to match the output speed of the main gearbox to the speed of the mobile machinery and match the torque to what is required to wind the cable.

Conductix-Wampfler gearboxes are lubricated for 5-year life or 15,000 operating hours.



Free Wheel

The free wheel ("backstop bearing"), prevents the cable/hose from unwinding due to its own weight when the drive motor is switched off. However, it is possible to intentionally unwind the cable/hose by applying a pull stronger than the magnetic coupler torque.

This component acts as a safety brake.



Magnetic Coupler

This sub-assembly is composed of a magnetic coupler, an electric motor, and a free wheel (also called the "backstop bearing").

- The motor turns at nameplate speed irrespective of the mobile travel speed.
- The coupler is driven at a constant speed.
- Three motor sizes are available depending on the type of coupler: 0.37 kW - 0.75 kW - 1.5 kW (@ 1,500 rpm)
- The most commonly used motor is the AC - 3 phase, IP 55, insulation class F, complying with the international standards such as IEC or NEMA.
- Other types of motors are available on request : voltage, cycles, protection degree, pneumatic or hydraulic motor ...



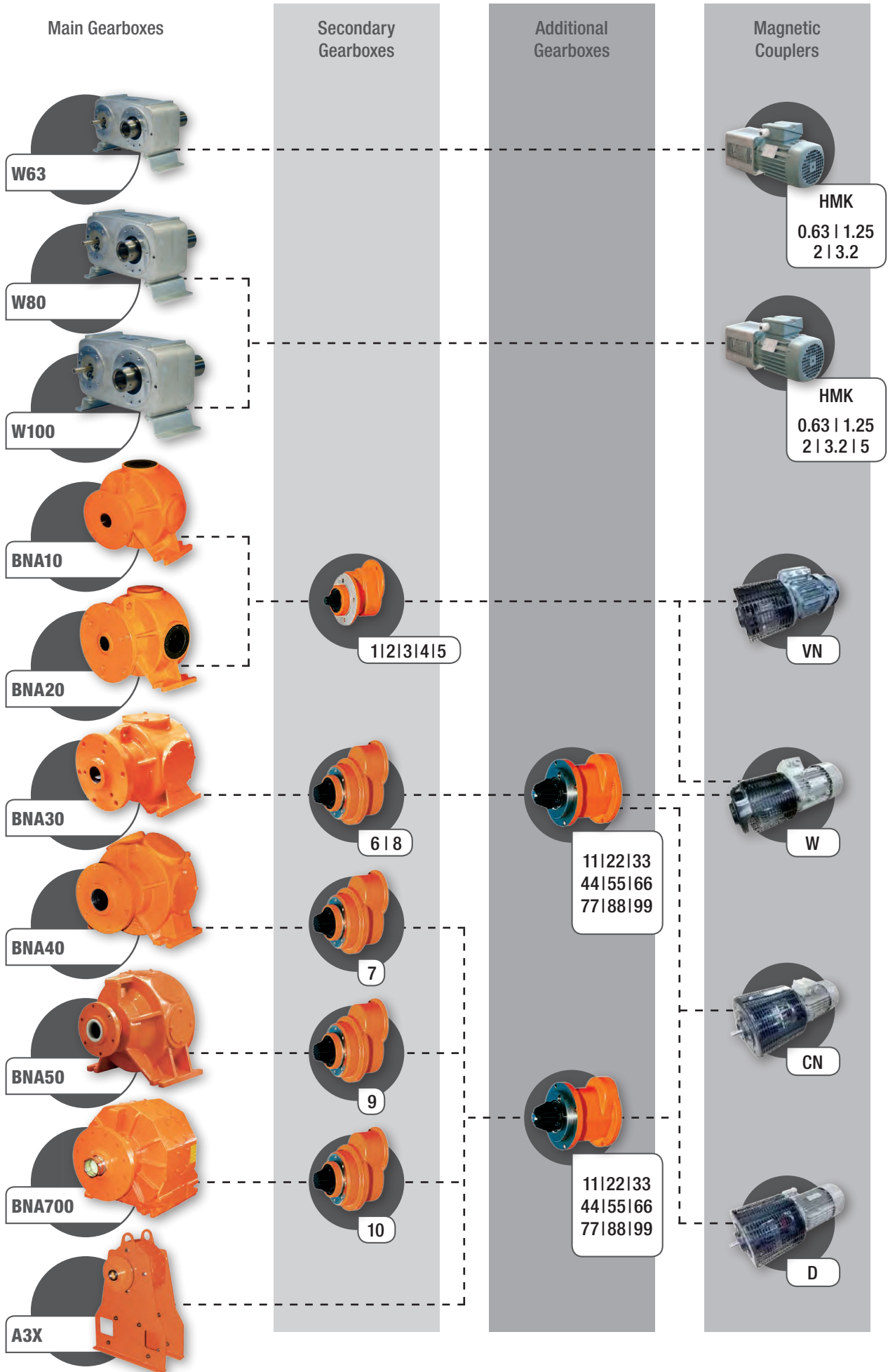

Spools

The spool is one of the most critical components of a motor driven reel system. Choosing the ideal spool will optimize performance and maximize the life of the cable. The right spool can increase maintenance cycles and avoid downtime.

With either a standard or a customized solution, Conductix-Wampfler is always able to provide the best type of spool for your application.

• Random Wind Spools

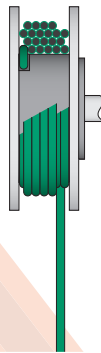

• 3-2-3 Spools

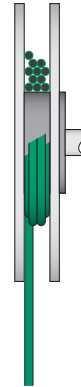

The **Random Wind Spool** is particularly suited for short or medium lengths of cable or hose.

During winding, the cable is naturally distributed around the drum without any cable guide system.

3-2-3 Spools are a combination of Monospiral and Random Wind Spools, where the cable is stacked in layers, each three cable diameters wide.

The 3-2-3 spool is generally used when space available for the spool is limited.

Double Monospiral Spool, with two identical cables with large cross-sections.



Level Wind Spool
with power cable on
a stacker / reclaimer

• Monospiral Spools



• Level Wind Spool

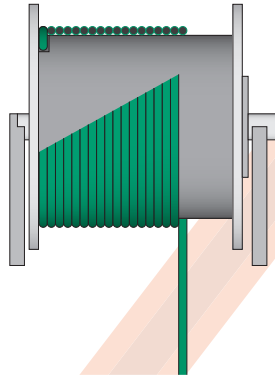

• Special Spools



The **Monospiral Spool** wraps the cable in the same plane and prevents the cable from twisting. It is your guarantee of a longer cable life.

Monospiral Spools offer maximum exposure to ambient air and best cooling of the cable.

The largest Monospiral Spools can accommodate up to 700 meters of cable.

Level Wind Spools are designed to accommodate cables that are 1,000 meters or longer.

The cable is wound in one, two, or three layers on a cylindrical drum. The cable is layered with a guide system driven by the reel drum.

By request, Conductix-Wampfler can build **Special Spools** such as:

- Double monospiral spools
- Plain monospiral spools
- Spools with alternate materials such as stainless steel
- Spools with special protection and/or dimensions
- Spools with reinforced construction for harsh applications.

Rotary Joints

Slip Ring Assemblies

Conductix-Wampfler has decades of experience in the design and manufacture of slip ring assemblies.

Our slip ring assemblies comply with IEC, UL, NEMA, and VDE international standards among others. Conductix-Wampfler slip ring assemblies are designed for the following applications:



Power

- Low voltage up to 690 V and 1250 A
- High voltage up to 36,000 V and 500 A
- 100% duty cycle

Control + Data

- Low voltage up to 690 V and 25 A
- Data transmission from controls and measurement devices, as well as from, computer, audio-video, and telecom equipment.
- 100% duty cycle

Mixed Construction

- Mixed power and control slip ring assemblies
- Rings of the same or different diameters on the same assembly

Fiber Optic Transmitter (TFO)



Conductix-Wampfler was one of the first cable reel manufacturers to develop a fiber optic transmitter that could meet industrial requirements.

Fiber optic cables are ideal for transmitting large amounts of information over long distances.

- Optic fibers:
 - single-mode (9/125) or
 - multi-mode (50/125 and 62.5/125)
- Attenuation:
 - single-mode: < 1.5 dB
 - multi-mode: < 1.0 dB
- Available in models that provide 40, 80, or 120 turns and 6, 12, 18, or 24 fibers
- Standard connectors are type ST (types FC, SC and others available by request)

Rotary Joint (for hose reels)



For the transfer of air, gases, or fluids, motorized reels can be equipped with a single or multi-channel rotary joint.

- Available pipe thread diameters:
 $\frac{3}{8}$ " - $\frac{1}{2}$ " - $\frac{3}{4}$ " - 1" - 1 $\frac{1}{4}$ " - 1 $\frac{1}{2}$ " -
 2" - 2 $\frac{1}{2}$ " - 3"
- The rotary joints have a standard Kanigen® (electroless nickel) plating.

High Voltage Slip Ring Enclosures

There are two versions of customized housing solutions available:

Eco

- Stainless steel 304L
- IP66
- Anti condensation resistance and gore breathers
- Shock absorbing mounting feet
- Removable undrilled cable gland support plates

Ergo

- Same as *Eco* plus:
- Top cover mounted on hinges and gas cylinders.
 - Locks by spring-energized latches only
 - Two side inspection windows (Lexan) with rubber protective flaps to avoid dirt and UV degradation.



Optional features for all versions:

- adaptation of trapped key interlocks
- 316L material
- fitting of cable glands for customer cables

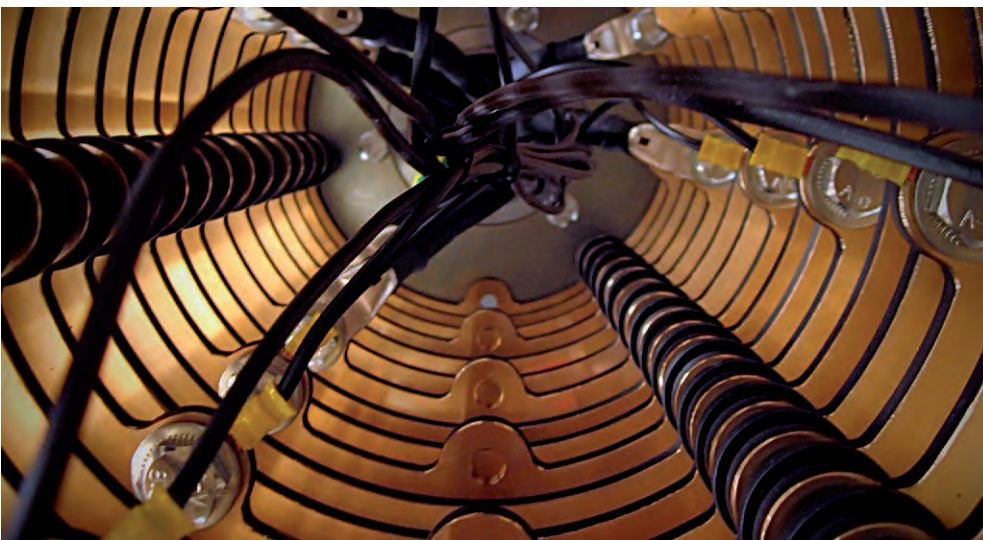



Accessories

Conductix-Wampfler offers a complete range of accessories for motorized reels...

- ❶ Connection boxes for power, control, and optic fiber
- ❷ One-way or two-way cable guides with optional slack-cable, over-pull, and position detectors
- ❸ Cable entries and anchor drums
- ❹ Guiding and diverting devices
- ❺ End limit switches
- ❻ Anchoring device with shock absorber springs for vertical applications
- ❼ On-ground "Angel-Wing" anchor drums
- ❽ Strip heaters to reduce condensation in slip ring housings (not shown)

Many more accessories are available; contact us for details.



Trenchguard® Cable Protection System

The system includes:

- Galvanized or stainless steel pre-manufactured trench channel
- Reinforced flexible rubber belt
- Stainless steel mounting hardware
- Belt lifting rollers mounted on the cable guide

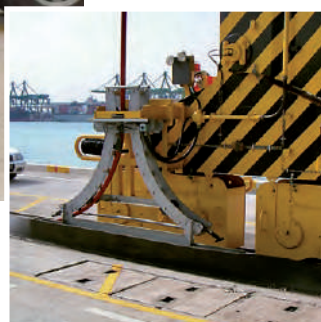





Customized Services

The scope and depth of the Conductix-Wampfler service range are based on the requests and requirements of our customers.

We can handle anything from project planning to long-term service agreements. For maximum operational life and the continued safety of complex systems, you should consider using our experienced service team.

At the planning stage we:

- Define the application parameters
- Select the most suitable motorized reel system and cable or hose
- Optimize the whole system to your requirements, application parameters, and environmental factors

Maintenance and service

- Regular maintenance and inspections increase the operational life of the installation and ensure long-term performance and availability
- A Conductix-Wampfler service agreement is your "Worry Free Package"!

At the pre-assembly stage we:

- Assemble the reel system
- Install the cable and connect the slip ring assembly
- Pre-adjust the parameters of the variable frequency drive units



At the final assembly and inspection stage we:

- Determine any additional assembly that needs to be performed on-site
- Complete the installation and commissioning using highly trained and experienced personnel
- Perform the final inspection
- Train and debrief the customers' personnel on-site



The experts at Conductix-Wampfler assist customers from planning through pre-assembly right up to the on-site installation - anywhere in the world





Your Applications – our Solutions

Motor driven reels with **MAG Drive** from Conductix-Wampfler represent only one of the many solutions made possible by the broad spectrum of Conductix-Wampfler components for the transport of energy, data, gases, and fluids. The solutions we deliver for your applications are based on your specific requirements. In many cases, a combination of several different Conductix-Wampfler systems can prove advantageous. You can count on all of Conductix-Wampfler's Business Units for hands-on engineering support - coupled with the perfect solution to meet your energy management and control needs.



Festoon systems

It's hard to imagine Conductix-Wampfler cable trolleys not being used in virtually every industrial application. They're reliable and robust and available in an enormous variety of dimensions and designs.

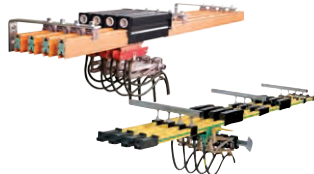

Conductor rails

Whether they're enclosed conductor rails or expandable single-pole systems, the proven conductor rails by Conductix-Wampfler reliably move people and material.

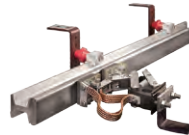

Non-insulated conductor rails

Extremely robust, non-insulated conductor rails with copper heads or stainless steel surfaces provide the ideal basis for rough applications, for example in steel mills or shipyards.



Slip ring assemblies

Whenever things are really "moving in circles", the proven slip ring assemblies by Conductix-Wampfler ensure the flawless transfer of energy and data. Here, everything revolves around flexibility and reliability!



Motorized Cable & Hose Reels

Motorized reels by Conductix-Wampfler hold their own wherever energy, data, media and fluids have to cover the most diverse distances within a short amount of time – in all directions, fast and safe.



Spring Cable & Hose Reels

With their robust and efficient design Spring Cable and Hose Reels from Conductix-Wampfler are unbeatably reliable in supplying energy, signals, data and fluids to a vast range of tools, cranes and vehicles.



Inductive Power Transfer IPT®

The no-contact system for transferring energy and data. For all tasks that depend on high speeds and absolute resistance to wear.



Retractors and Balancers

Our wide range of high reliable retractors and balancers remove the load from your shoulders and allow you to reach top productivity.



Energy guiding chains

The "Jack of all trades" when it comes to transferring energy, data, air and fluid hoses. With their wide range, these energy guiding chains are the ideal solution for many industrial applications.



Jib booms

Complete with tool transporters, reels, or an entire media supply system – here, safety and flexibility are key to the completion of difficult tasks.

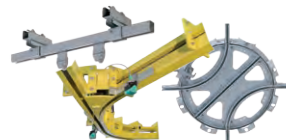

Conveyor systems

Whether manual, semiautomatic or with Power & Free – flexibility is achieved with full customization concerning layout and location.

www.conductix.com

Conductix-Wampfler has just one critical mission:

To provide you with energy and data transmission systems that will keep your operations up and running 24/7/365.

To contact your nearest sales office, please refer to:

www.conductix.com/contact-search

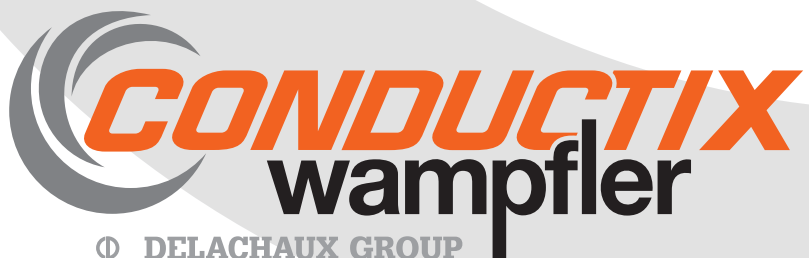

DELACHAUX GROUP