

MFS Series Water-Proof Slip Rings



Features

- Designed specifically for underwater operation and waterproof work.
- Industrial grade products; IP65,IP68 protection grade.
- Gold-gold contact;adopting imported seals and military grade plating treatment.
- Multi-point contacts;outgoing line uses waterproof gran circle and cable.
- Can be customized on your request.

MFS Series Models

Model#	ID (mm)	OD (mm)	10A Circuits	Signal(5a) Circuits	IP Grade
MFS028	0	28	1~6	1~24	IP68
MFS038	0	38	1~6	1~56	IP68
MFS056	0	56	1~24	1~42	option for IP65 , IP68
MFS086	0	86	1~36	1~72	option for IP65 , IP68
MFS1025	25.4	86	1~36	1~72	option for IP65 , IP68
MFS1050	50	119	1~36	1~72	option for IP65 , IP68

60% of moflon's sales are customized solutions, please contact customer service for special requirements.

MFS028 Series

Water-proof/underwater IP68 Slip Ring

- Designed specifically for underwater operation and waterproof work.
- Industrial grade products;stator flange; IP68 protection grade.
- Gold-gold contact;adopting imported seals and military grade plating treatment.
- Multi-point contacts;outgoing line uses waterproof gran circle and cable.
- Can be customized on your request.

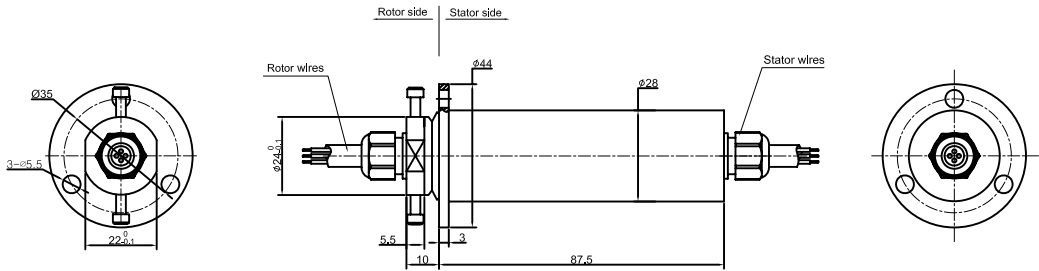

Part# Explanation

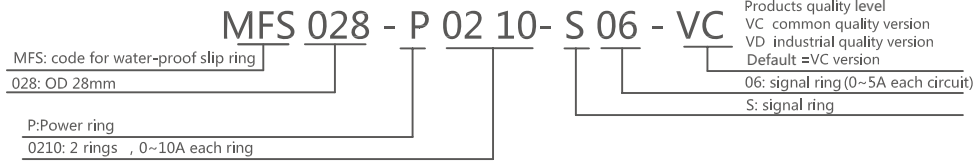

Part# List

MFS028-series water-proof/under water slip ring part list

Part#	Signal 2A	5A	10A	20A	Length(mm)
MFS028-S06	6	0	0	0	87.5
MFS028-S12	12	0	0	0	87.5
MFS028-S18	18	0	0	0	87.5
MFS028-S24	24	0	0	0	87.5
MFS028-P0320	0	0	0	3	87.5
MFS028-P0205-S16	16	2	0	0	87.5
MFS028-P0210-S12	12	0	2	0	87.5
MFS028-P0310-S08	8	0	3	0	87.5

Note:N channels 5A rings parallel can be used as 1 channel N*5A current. For example: 2 rings 5A parallel could be used as 1 wires 10A

Specifications

Mechanical Data		Electrical Data		
Parameter	Value	Parameter	Value	
Working Life	See product quality level table	Rated Voltage	Power	Signal
Rotating Speed	See product quality level table		0~440VAC/VDC	0~440VAC/VDC
Working Temperature	-30°C~80°C	Insulation Resistance	≥1000MΩ/500VDC	≥1000MΩ/500VDC
Operating Humidity	0~85% RH	Lead Wires	Water-proof cable	Water-proof cable
Contact Material	See product quality level table	Lead Length	Standard 300mm (adjustable)	
Housing Materia	aluminium alloy	Dielectric Strength	500VAC@50Hz , 60s	
Torque	0.5N.m ; +0.03N.m/6 circuits	Electrical Noise	<0.01Ω	
Protection Grade	IP68			

Product Quality Level Table

Products Level Code	Max Rotating Speed	Working Life	Contact Material
VC	100RPM	10 Million Rev	Precious Metal
VD	200RPM	30 Million Rev	Gold-Gold

Options For Custom Slip Ring

Note: Below special demands can be customized. According, the delivery date will be extended 3 to 15 days; also the cost will be increased 30% to 50%. Most of our basic parts are standard and modular, which can save the cost and lead time.

- ① Cable exit way and cable length can be customized for both rotor and stator.
- ② Because of the structure limitation, length/height/OD can be customized on your request.
- ③ Support current or signal up to 200 rings.
- ④ Aviation plug, terminal and heat-shrink tube are optional.
- ⑤ Hybrid slip ring for Yaskawa/Panasonic/Siemens servo control signal, power line and encoder line.
- ⑥ Support mixed high speed data transmission (including Ethernet, USB, RS232, RS485, Profibus, CanBUS, CANOPEN, DeviceNET, CC-LINK, ProfiNET, EtherCAT, etc.)
- ⑦ Can combine temperature control signal with thermocouple signal.
- ⑧ Special environment can be customized, such as quakeproof, high temperature, etc.
- ⑨ Hybrid Pneumatic/hydraulic and electric slip ring can be mixed.
- ⑩ High temperature can up to 500 degrees.
- ⑪ High pressure can up to 110KV
- ⑫ Rotating speed can up to 10000RPM
- ⑬ Maximum current can up to 5000 amperes.
- ⑭ Military grade
- ⑮ Optional for underwater IP65, IP68.
- ⑯ Optional for stainless steel housing

Technical support: technical@moflon.com

MFS038 Series

Water-proof/under Water IP68 Slip Ring

- Designed specifically for underwater operation and waterproof work.
- Industrial grade products;stator flange; IP68 protection grade.
- Gold-gold contact;adopting imported seals and military grade plating treatment.
- Multi-point contacts;outgoing line uses waterproof gran circle and cable.
- Can be customized on your request.

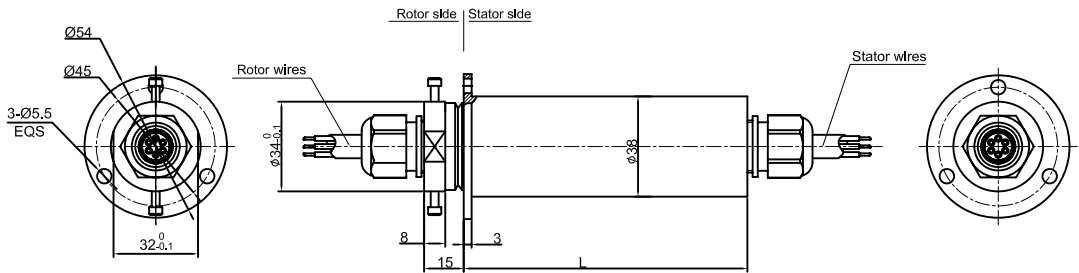

Part# Explanation

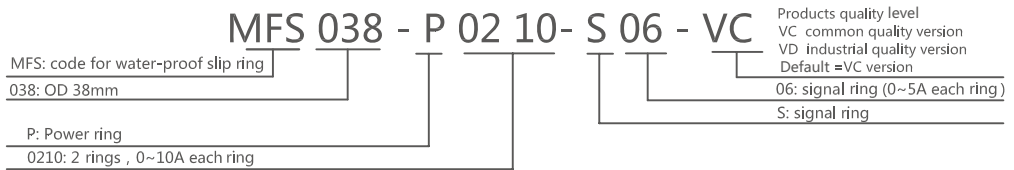

Part# List

MFS038 - series water-proof/under water slip ring part list

Part#	Signal or 2A	10A	20A	Length (mm)	Part#	Signal or 2A	10A	20A	Length (mm)
MFS038-P0610	0	6	0	107.5	MFS038-S56	56	0	0	146.5
MFS038-P0620	0	0	6	107.5	MFS038-P1210	0	12	0	146.5
MFS038-P0210-S04	4	2	0	107.5	MFS038-P0210-S10	10	2	0	146.5
MFS038-S0220-S04	4	0	2	107.5	MFS038-P0410-S08	8	4	0	146.5
MFS038-S0410-S02	2	4	0	107.5	MFS038-P0610-S06	6	6	0	146.5
MFS038-P0420-S02	2	0	4	107.5	MFS038-P0810-S04	4	8	0	146.5
MFS038-P0310-S03	3	3	0	107.5	MFS038-P1010-S02	2	10	0	146.5
MFS038-P0320-S03	3	0	3	107.5	MFS038-S12	12	0	0	146.5
MFS038-S36	36	0	0	107.5					

Note:N channels 10A rings parallel can be used as 1 channel N*10A current. For example: 2 rings 10A parallel could be used as 1 wires 20A

Specifications

Parameter	Electrical Data	
	Power	Signal
Rated Voltage	0~440VAC/VDC	0~440VAC/VDC
Insulation Resistance	$\geq 1000M\Omega/500VDC$	$\geq 1000M\Omega/500VDC$
Lead Wires	Water-proof cable	Water-proof cable
Lead Length	Standard 300mm (adjustable)	
Dielectric Strength	500VAC@50Hz , 60s	
Electrical Noise	<0.01 Ω	

Mechanical Data	
Parameter	Value
Working Life	See product quality level table
Rotating Speed	See product quality level table
Working Temperature	-30°C~80°C
Operating Humidity	0~85% RH
Contact Material	See product quality level table
Housing Material	aluminium alloy
Torque	0.5N.m ; +0.03N.m/6 circuits
Protection Grade	IP68

Product Quality Level Table

Products Level Code	Max Rotating Speed	Working Life	Contact Material
VC	100RPM	10 Million Rev	Precious Metal
VD	200RPM	30 Million Rev	Gold-Gold

Options For Custom Slip Ring

Note: Below special demands can be customized. According, the delivery date will be extended 3 to 15 days; also the cost will be increased 30% to 50%. Most of our basic parts are standard and modular, which can save the cost and lead time.

- ① Cable exit way and cable length can be customized for both rotor and stator.
- ② Because of the structure limitation, length/height/OD can be customized on your request.
- ③ Support current or signal up to 200 rings.
- ④ Aviation plug, terminal and heat-shrink tube are optional.
- ⑤ Hybrid slip ring for Yaskawa/Panasonic/Siemens servo control signal, power line and encoder line.
- ⑥ Support mixed high speed data transmission (including Ethernet, USB, RS232, RS485, Profibus, CanBUS, CANOPEN, DeviceNET, CC-LINK, ProfiNET, EtherCAT, etc.)
- ⑦ Can combine temperature control signal with thermocouple signal.
- ⑧ Special environment can be customized, such as quakeproof, high temperature, etc.
- ⑨ Hybrid Pneumatic/hydraulic and electric slip ring can be mixed.
- ⑩ High temperature can up to 500 degrees.
- ⑪ High pressure can up to 110KV
- ⑫ Rotating speed can up to 10000RPM
- ⑬ Maximum current can up to 5000 amperes.
- ⑭ Military grade
- ⑮ Optional for underwater IP65, IP68.
- ⑯ Optional for stainless steel housing

Technical support: technical@moflon.com

MFS056 Series Slip Ring

- Designed specifically for underwater operation and waterproof work.
- Industrial grade products;stator flange; IP65,IP68 protection grade.
- Gold-gold contact;adopting imported seals and military grade plating treatment.
- Multi-point contacts;outgoing line uses waterproof gran circle and cable.
- Can be customized on your request.

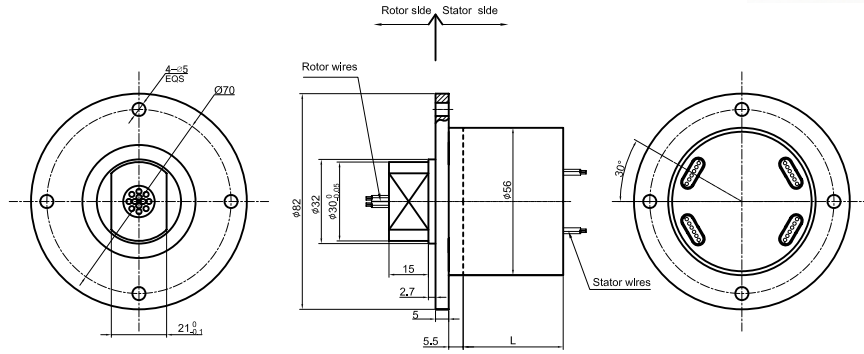

Part# Explanation

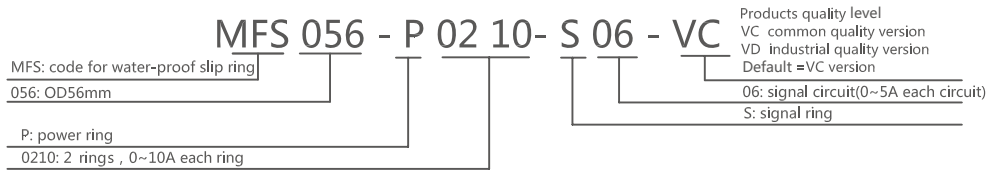

Part# List

MFS056-series water-proof/underwater slip ring part list							
Part#	Signal or 5A	10A	Length (mm)	Part#	Signal or 5A	10A	Length (mm)
MFS056-P0610	0	6	38	MFS056-S06	6	0	38
MFS056-P0210-S04	4	2	38	MFS056-P0410-S02	2	4	38
MFS056-P1210	0	12	54.8	MFS056-S12	12	0	54.8
MFS056-P0210-S10	10	2	54.8	MFS056-P0410-S08	8	4	54.8
MFS056-P0610-S06	6	6	54.8	MFS056-P0810-S04	4	8	54.8
MFS056-P1010-S02	2	10	54.8	MFS056-S18	18	0	71.5
MFS056-P1810	0	18	71.5	MFS056-P0410-S14	14	4	71.5
MFS056-P0210-S16	16	2	71.5	MFS056-P0810-S10	10	8	71.5
MFS056-P0610-S12	12	6	71.5	MFS056-P1210-S06	6	12	71.5
MFS056-P1010-S08	8	10	71.5	MFS056-P1610-S02	2	16	71.5
MFS056-P1410-S04	4	14	71.5	MFS056-S24	24	0	88.4
MFS056-P2410	0	24	88.4	MFS056-P1210-S12	12	12	88.4
MFS056-P0610-S18	18	6	88.4	MFS056-P1810-S06	6	18	88.4

Note:N channels 10A rings parallel can be used as 1 channel N*10A current. For example: 2 rings 10A parallel could be used as 1 wires 20A

Specifications

Electrical Data		
Parameter	Value	
	Power	Signal
Rated Voltage	0~440VAC/VDC	0~440VAC/VDC
Insulation Resistance	≥1000MΩ/500VDC	≥1000MΩ/500VDC
Lead Wires	AWG#16 teflon	AWG#22 teflon
Lead Length	Standard 300mm (adjustable)	
Dielectric Strength	500VAC@50Hz , 60s	
Electrical Noise	<0.01Ω	
Mechanical Data		
Parameter	Value	
Working Life	See product quality level table	
Rotating Speed	See product quality level table	
Working Temperature	-30°C~80°C	
Operating Humidity	0~85% RH	
Contact Material	See product quality level table	
Housing Material	aluminium alloy	
Torque	1.0N.m ; +0.03N.m/6 circuits	
Protection Grade	IP65, IP68 on request	

Product Quality Level Table

Products Level Code	Max Rotating Speed	Working Life	Contact Material
VC	200RPM	15 Million Rev	Precious Metal
VD	600RPM	80 Million Rev	Gold-Gold

Options For Custom Slip Ring

Note: Below special demands can be customized. According, the delivery date will be extended 3 to 15 days; also the cost will be increased 30% to 50%. Most of our basic parts are standard and modular, which can save the cost and lead time.

- ① Cable exit way and cable length can be customized for both rotor and stator.
- ② Because of the structure limitation, length/height/OD can be customized on your request.
- ③ Support current or signal up to 200 rings.
- ④ Aviation plug, terminal and heat-shrink tube are optional.
- ⑤ Hybrid slip ring for Yaskawa/Panasonic/Siemens servo control signal, power line and encoder line.
- ⑥ Support mixed high speed data transmission (including Ethernet, USB, RS232, RS485, Profibus, CanBUS, CANOPEN, DeviceNET, CC-LINK, ProfiNET, EtherCAT, etc.)
- ⑦ Can combine temperature control signal with thermocouple signal.
- ⑧ Special environment can be customized, such as quakeproof, high temperature, etc.
- ⑨ Hybrid Pneumatic/hydraulic and electric slip ring can be mixed.
- ⑩ High temperature can up to 500 degrees.
- ⑪ High pressure can up to 110KV
- ⑫ Rotating speed can up to 10000RPM
- ⑬ Maximum current can up to 5000 amperes.
- ⑭ Military grade
- ⑮ Optional for underwater IP65, IP68.
- ⑯ Optional for stainless steel housing

Technical support: technical@moflon.com

MFS086 Series Slip Ring

- Designed specifically for underwater operation and waterproof work.
- Industrial grade products;stator flange; IP65,IP68 protection grade.
- Gold-gold contact;adopting imported seals and military grade plating treatment.
- Multi-point contacts;outgoing line uses waterproof gran circle and cable.
- Can be customized on your request.

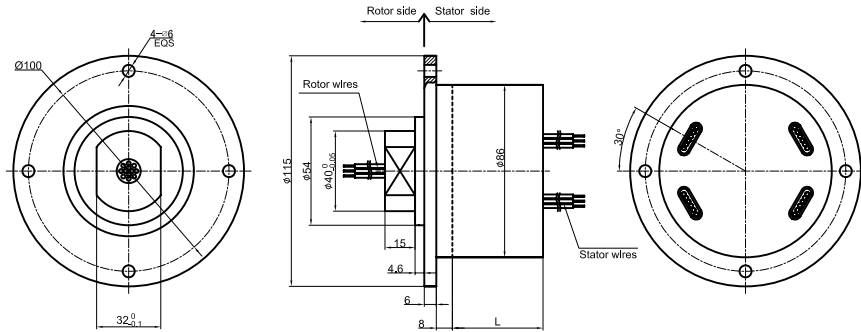

Part# Explanation

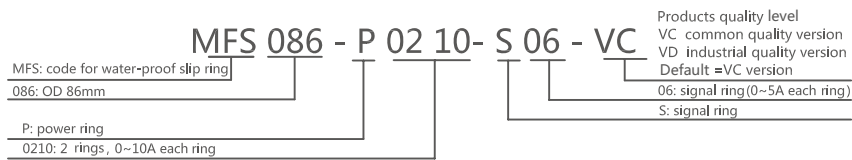

Part# List

MFS086-series water-proof/underwater slip ring part list							
Part#	Signal or 5A	10A	Length (mm)	Part#	Signal or 5A	10A	Length (mm)
MFS086-P0610	0	6	45.2	MFS086-S06	6	0	45.2
MFS086-P0210-S04	4	2	45.2	MFS086-P0410-S02	2	4	45.2
MFS086-P1210	0	12	65.6	MFS086-S12	12	0	65.6
MFS086-P0210-S10	10	2	65.6	MFS086-P0410-08	8	4	65.6
MFS086-P06-S06	6	6	65.6	MFS086-P0810-S04	4	8	65.6
MFS086-P1010-S02	2	10	65.6	MFS086-S18	18	0	86
MFS086-P1810	0	18	86	MFS086-P0410-S14	14	4	86
MFS086-P0210-S16	16	2	86	MFS086-P0810-S10	10	8	86
MFS086-P0610-S12	12	6	86	MFS086-P1210-S06	6	12	86
MFS086-P1010-S08	8	10	86	MFS086-P1610-S02	2	16	86
MFS086-P1410-S04	4	14	86	MFS086-S24	24	0	106.4
MFS086-P24	0	24	106.4	MFS086-P1210-S12	12	12	106.4
MFS086-P0610-S18	18	6	106.4	MFS086-P0610-S24	24	6	134
MFS086-P1810-S06	6	18	106.4	MFS086-S36	36	0	150.2
MFS086-S30	30	0	126.8	MFS086-P1210-S24	24	12	150.2
MFS086-P1210-S18	18	12	126.8	MFS086-P0610-S36	36	6	170.6
MFS086-P0610-S30	30	6	150.2	MFS086-S48	48	0	191
MFS086-S42	42	0	170.6	MFS086-P1210-S36	36	12	191
MFS086-P1210-S30	30	12	170.6	MFS086-P0610-S54	54	6	231.8
MFS086-P0610-S42	42	6	191	MFS086-S72	72	0	275.6
MFS086-S60	60	0	231.8	MFS086-P1210-S60	60	12	275.6
MFS086-P1210-S48	48	12	231.8	MFS086-P0610-S66	66	6	275.6

Note:N channels 10A rings parallel can be used as 1 channel N*10A current. For example: 2 rings 10A parallel could be used as 1 wires 20A

Specifications

Electrical Data		
Parameter	Value	
	Power	Signal
Rated Voltage	0~440VAC/VDC	0~440VAC/VDC
Insulation Resistance	≥1000MΩ/500VDC	≥1000MΩ/500VDC
Lead Wires	Water-proof cable	Water-proof cable
Lead Length	Standard 300mm (adjustable)	
Dielectric Strength	500VAC@50Hz , 60s	
Electrical Noise	<0.01Ω	
Mechanical Data		
Parameter	Value	
Working Life	See product quality level table	
Rotating Speed	See product quality level table	
Working Temperature	-30°C~80°C	
Operating Humidity	0~85% RH	
Contact Material	See product quality level table	
Housing Material	aluminium alloy	
Torque	1.0N.m ; +0.03N.m/6 circuits	
Protection Grade	IP65, IP68 on request	

Product Quality Level Table

Products Level Code	Max Rotating Speed	Working Life	Contact Material
VC	200RPM	15 Million Rev	Precious Metal
VD	600RPM	80 Million Rev	Gold-Gold

Options For Custom Slip Ring

Note: Below special demands can be customized. According, the delivery date will be extended 3 to 15 days; also the cost will be increased 30% to 50%. Most of our basic parts are standard and modular, which can save the cost and lead time.

- ① Cable exit way and cable length can be customized for both rotor and stator.
- ② Because of the structure limitation, length/height/OD can be customized on your request.
- ③ Support current or signal up to 200 rings.
- ④ Aviation plug, terminal and heat-shrink tube are optional.
- ⑤ Hybrid slip ring for Yaskawa/Panasonic/Siemens servo control signal, power line and encoder line.
- ⑥ Support mixed high speed data transmission (including Ethernet, USB, RS232, RS485, Profibus, CanBUS, CANOPEN, DeviceNET, CC-LINK, ProfiNET, EtherCAT, etc.)
- ⑦ Can combine temperature control signal with thermocouple signal.
- ⑧ Special environment can be customized, such as quakeproof, high temperature, etc.
- ⑨ Hybrid Pneumatic/hydraulic and electric slip ring can be mixed.
- ⑩ High temperature can up to 500 degrees.
- ⑪ High pressure can up to 110KV
- ⑫ Rotating speed can up to 10000RPM
- ⑬ Maximum current can up to 5000 amperes.
- ⑭ Military grade
- ⑮ Optional for underwater IP65, IP68.
- ⑯ Optional for stainless steel housing

Technical support: technical@moflon.com

MFS1025 Series Slip Ring

- Designed specifically for underwater operation and waterproof work.
- Industrial grade products; IP65,IP68 protection grade.
- Gold-gold contact;adopting imported seals and military grade plating treatment.
- Multi-point contacts;outgoing line uses waterproof gran circle and cable.
- Can be customized on your request.

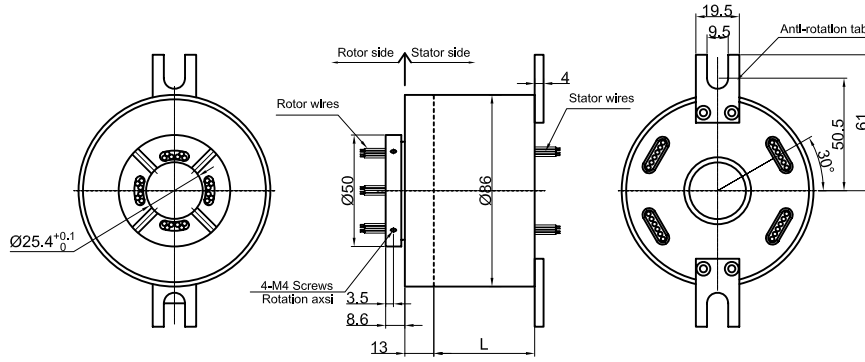

Part# Explanation

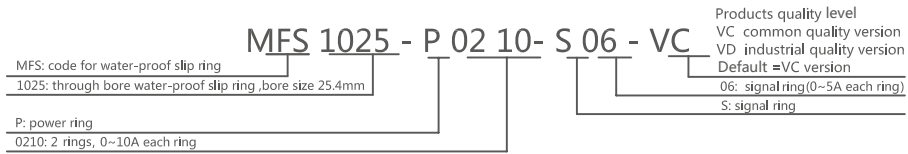

Part# List

MFS1025 Series slip ring							
Part#	Signal or 5A	10A	Length (mm)	Part#	Signal or 5A	10A	Length (mm)
MFS1025-P0610	0	6	45.2	MFS1025-S06	6	0	45.2
MFS1025-P0210-S04	4	2	45.2	MFS1025-P0410-S02	2	4	45.2
MFS1025-P1210	0	12	65.6	MFS1025-S12	12	0	65.6
MFS1025-P0210-S10	10	2	65.6	MFS1025-P0410-08	8	4	65.6
MFS1025-P06-S06	6	6	65.6	MFS1025-P0810-S04	4	8	65.6
MFS1025-P1010-S02	2	10	65.6	MFS1025-S18	18	0	86
MFS1025-P1810	0	18	86	MFS1025-P0410-S14	14	4	86
MFS1025-P0210-S16	16	2	86	MFS1025-P0810-S10	10	8	86
MFS1025-P0610-S12	12	6	86	MFS1025-P1210-S06	6	12	86
MFS1025-P1010-S08	8	10	86	MFS1025-P1610-S02	2	16	86
MFS1025-P1410-S04	4	14	86	MFS1025-S24	24	0	106.4
MFS1025-P24	0	24	106.4	MFS1025-P1210-S12	12	12	106.4
MFS1025-P0610-S18	18	6	106.4	MFS1025-P0610-S24	24	6	134
MFS1025-P1810-S06	6	18	106.4	MFS1025-S36	36	0	150.2
MFS1025-S30	30	0	126.8	MFS1025-P1210-S24	24	12	150.2
MFS1025-P1210-S18	18	12	126.8	MFS1025-P0610-S36	36	6	170.6
MFS1025-P0610-S30	30	6	150.2	MFS1025-S48	48	0	191
MFS1025-S42	42	0	170.6	MFS1025-P1210-S36	36	12	191
MFS1025-P1210-S30	30	12	170.6	MFS1025-P0610-S54	54	6	231.8
MFS1025-P0610-S42	42	6	191	MFS1025-S72	72	0	275.6
MFS1025-S60	60	0	231.8	MFS1025-P1210-S60	60	12	275.6
MFS1025-P1210-S48	48	12	231.8	MFS1025-P0610-S66	66	6	275.6

Note:N channels 10A rings parallel can be used as 1 channel N*10A current. For example: 2 rings 10A parallel could be used as 1 wires 20A

Specifications

Electrical Data		
Parameter	Value	
	Power	Signal
Rated Voltage	0~440VAC/VDC	0~440VAC/VDC
Insulation Resistance	≥1000MΩ/500VDC	≥1000MΩ/500VDC
Lead Wires	Water-proof cable	Water-proof cable
Lead Length	Standard 300mm (adjustable)	
Dielectric Strength	500VAC@50Hz , 60s	
Electrical Noise	<0.01Ω	
Mechanical Data		
Parameter	Value	
Working Life	See product quality level table	
Rotating Speed	See product quality level table	
Working Temperature	-30°C~80°C	
Operating Humidity	0~85% RH	
Contact Material	See product quality level table	
Housing Materia	aluminium alloy	
Torque	1.0N.m ; +0.03N.m/6 circuits	
Protection Grade	IP65, IP68 on request	

Product Quality Level Table

Products Level Code	Max Rotating Speed	Working Life	Contact Material
VC	100RPM	10 Million Rev	Precious Metal
VD	300RPM	40 Million Rev	Gold-Gold

Options For Custom Slip Ring

Note: Below special demands can be customized. According, the delivery date will be extended 3 to 15 days; also the cost will be increased 30% to 50%. Most of our basic parts are standard and modular, which can save the cost and lead time.

- ① Bore diameter can be customized;cable exit way and cable length can be customized for both rotor and stator.
- ② Because of the structure limitation, length/height/OD can be customized on your request.
- ③ Support current or signal up to 200 rings.
- ④ Aviation plug, terminal and heat-shrink tube are optional.
- ⑤ Hybrid slip ring for Yaskawa/Panasonic/Siemens servo control signal, power line and encoder line.
- ⑥ Support mixed high speed data transmission (including Ethernet, USB, RS232, RS485, Profibus, CanBUS, CANOPEN, DeviceNET, CC-LINK, ProfiNET, EtherCAT, etc.)
- ⑦ Can combine temperature control signal with thermocouple signal.
- ⑧ Special environment can be customized, such as quakeproof, high temperature, etc.
- ⑨ Hybrid Pneumatic/hydraulic and electric slip ring can be mixed.
- ⑩ High temperature can up to 500 degrees.
- ⑪ High pressure can up to 110KV
- ⑫ Rotating speed can up to 10000RPM
- ⑬ Maximum current can up to 5000 amperes.
- ⑭ Military grade
- ⑮ Optional for underwater IP65, IP68.
- ⑯ Optional for stainless steel housing

Technical support: technical@moflon.com

MFS1050 Series Slip Ring

- Designed specifically for underwater operation and waterproof work.
- Industrial grade products; IP65,IP68 protection grade.
- Gold-gold contact;adopting imported seals and military grade plating treatment.
- Multi-point contacts;outgoing line uses waterproof gran circle and cable.
- Can be customized on your request.

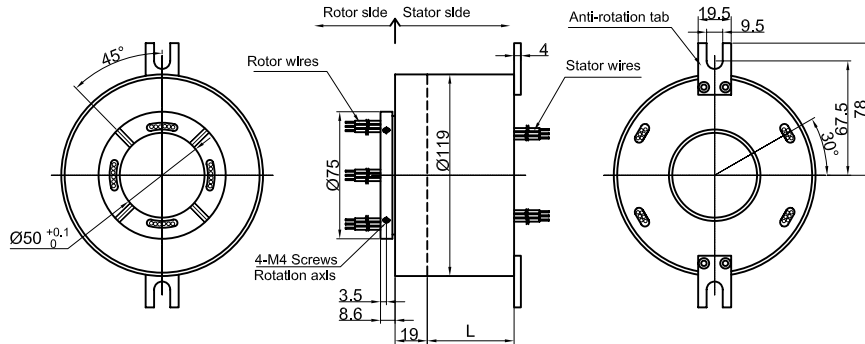

Part# Explanation

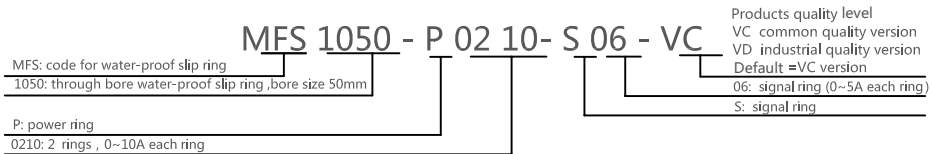

Part# List

MFS1050 Series slip ring							
Part#	Signal or 5A	10A	Length (mm)	Part#	Signal or 5A	10A	Length (mm)
MFS1050-P0610	0	6	51.2	MFS1050-S06	6	0	51.2
MFS1050-P0210-S04	4	2	51.2	MFS1050-P0410-S02	2	4	51.2
MFS1050-P1210	0	12	74	MFS1050-S12	12	0	74
MFS1050-P0210-S10	10	2	74	MFS1050-P0410-08	8	4	74
MFS1050-P06-S06	6	6	74	MFS1050-P0810-S04	4	8	74
MFS1050-P1010-S02	2	10	74	MFS1050-S18	18	0	96.8
MFS1050-P1810	0	18	96.8	MFS1050-P0410-S14	14	4	96.8
MFS1050-P0210-S16	16	2	96.8	MFS1050-P0810-S10	10	8	96.8
MFS1050-P0610-S12	12	6	96.8	MFS1050-P1210-S06	6	12	96.8
MFS1050-P1010-S08	8	10	96.8	MFS1050-P1610-S02	2	16	96.8
MFS1050-P1410-S04	4	14	96.8	MFS1050-S24	24	0	119.6
MFS1050-P24	0	24	119.6	MFS1050-P1210-S12	12	12	119.6
MFS1050-P0610-S18	18	6	119.6	MFS1050-P0610-S24	24	6	142.4
MFS1050-P1810-S06	6	18	119.6	MFS1050-S36	36	0	165.2
MFS1050-S30	30	0	142.4	MFS1050-P1210-S24	24	12	165.2
MFS1050-P1210-S18	18	12	142.4	MFS1050-P0610-S36	36	6	192
MFS1050-P0610-S30	30	6	165.2	MFS1050-S48	48	0	214.8
MFS1050-S42	42	0	192	MFS1050-P1210-S36	36	12	214.8
MFS1050-P1210-S30	30	12	192	MFS1050-P0610-S54	54	6	260.4
MFS1050-P0610-S42	42	6	214.8	MFS1050-S72	72	0	310
MFS1050-S60	60	0	260.4	MFS1050-P1210-S60	60	12	310
MFS1050-P1210-S48	48	12	260.4	MFS1050-P0610-S66	66	6	310

Note:N channels 10A rings parallel can be used as 1 channel N*10A current. For example: 2 rings 10A parallel could be used as 1 wires 20A

Specifications

Electrical Data		
Parameter	Value	
	Power	Signal
Rated Voltage	0~440VAC/VDC	0~440VAC/VDC
Insulation Resistance	≥1000MΩ/500VDC	≥1000MΩ/500VDC
Lead Wires	Water-proof cable	Water-proof cable
Lead Length	Standard 300mm (adjustable)	
Dielectric Strength	500VAC@50Hz , 60s	
Electrical Noise	<0.01Ω	
Mechanical Data		
Parameter	Value	
Working Life	See product quality level table	
Rotating Speed	See product quality level table	
Working Temperature	-30°C~80°C	
Operating Humidity	0~85% RH	
Contact Material	See product quality level table	
Housing Material	aluminium alloy	
Torque	1.0N.m ; +0.03N.m/6 circuits	
Protection Grade	IP65, IP68 on request	

Product Quality Level Table

Products Level Code	Max Rotating Speed	Working Life	Contact Material
VC	100RPM	10 Million Rev	Precious Metal
VD	300RPM	30 Million Rev	Gold-Gold

Options For Custom Slip Ring

Note: Below special demands can be customized. According, the delivery date will be extended 3 to 15 days; also the cost will be increased 30% to 50%. Most of our basic parts are standard and modular, which can save the cost and lead time.

- ① Bore diameter can be customized; cable exit way and cable length can be customized for both rotor and stator.
- ② Because of the structure limitation, length/height/OD can be customized on your request.
- ③ Support current or signal up to 200 rings.
- ④ Aviation plug, terminal and heat-shrink tube are optional.
- ⑤ Hybrid slip ring for Yaskawa/Panasonic/Siemens servo control signal, power line and encoder line.
- ⑥ Support mixed high speed data transmission (including Ethernet, USB, RS232, RS485, Profibus, CanBUS, CANOPEN, DeviceNET, CC-LINK, ProfiNET, EtherCAT, etc.)
- ⑦ Can combine temperature control signal with thermocouple signal.
- ⑧ Special environment can be customized, such as quakeproof, high temperature, etc.
- ⑨ Hybrid Pneumatic/hydraulic and electric slip ring can be mixed.
- ⑩ High temperature can up to 500 degrees.
- ⑪ High pressure can up to 110KV
- ⑫ Rotating speed can up to 10000RPM
- ⑬ Maximum current can up to 5000 amperes.
- ⑭ Military grade
- ⑮ Optional for underwater IP65, IP68.
- ⑯ Optional for stainless steel housing

Technical support: technical@moflon.com